

Dishroom Equipment Catalogue





Contents

Dishwashing baskets 500 x 500 mm	4
Plate cassettes	5
Dishwashing baskets 460 mm system.....	6
Dishwashing baskets 460 x 460 mm	8
Cutlery handling	9
Kitchen trolleys	10
Trolleys for GN containers	11
Shelf trolleys.....	11
Service trolleys.....	12
Kindergarten trolleys	13
Basket trolleys	14
Basket dolly.....	14
Dispenser trolleys.....	15
Plate cassette trolleys	15
Dish return trolleys and combination trolleys	16
Basin trolleys	17
Cutlery soak trolley	17
Tray return trolleys.....	18
Multipurpose trolley	19
Transport trolley.....	19
Laundry trolley	19
Waste trolleys	20
Sack trolley	20
Waste cupboards	21
Racks for 500 x 500 mm baskets	22
Cutlery sorting rack.....	24
Basket rack	24
Storage rack.....	25
Pot and pan rack	25
Crate rack.....	25
Carousel system	26
Delivery carousel.....	27
Scraper	27
Delivery/sorting tables.....	28
Basket rack wall mounted.....	29
Pre-wash tables	30
Drying line	30
Pre-wash showers	31
Powered turn track.....	32
Roller table.....	33
Nordieflex returning and sorting units	34

Dishwashing Circle

The dishwashing material flow is an endless circle and the process contains the same stages, irrespective of whether small or large capacities are concerned. Handling dishes before and after the dishwasher causes the main use of labour costs in the process, so our innovative systems can bring substantial savings.

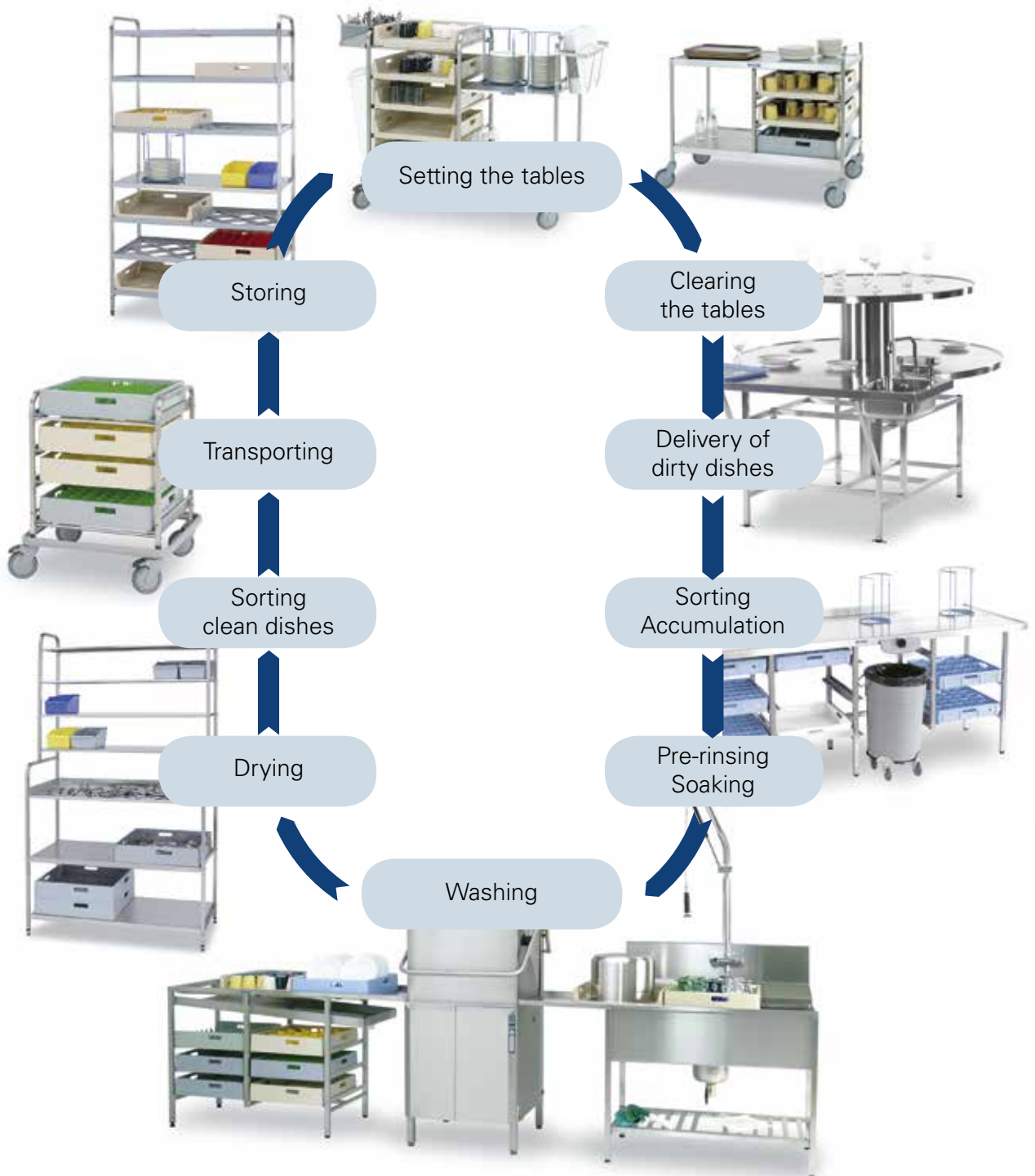

NORDIEN-SYSTEM DISHWASHING BASKETS 500 x 500 mm



Basket for cups and glasses

- Smooth sides – no water residue
- Diagonal handles – better balance and better grip
- Wide mesh – for better washing results
- Stackable – for safe transportation and storage
- Double wall construction – for strength and stability
- Injection moulded polypropylene
- Suitable for all types of dishwashing machines



Black basket for cups and glasses



Basket for cutlery

Basket for cups and glasses	Code	Glass h	Pc
010G, grey	4550000	70 mm	~30
010G, black	4550001	70 mm	~30
Service basket, cups/glasses			
050, beige	4550002	70 mm	~30
Basket for flat and deep plates		Plate Ø	
030, blue	4550004	240 mm	18/12
Basket for cutlery			
040, grey	4550006		
Basket for trays			
060, green	4550008		9



Basket for 18 flat or 12 deep plates



Basket for trays

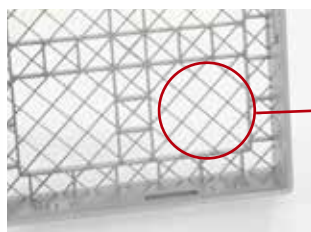

Open base guarantees a good wash result.



Service basket for cups and glasses with one low side for easy access to glasses and cups.

Compartment basket, grey	Code	Glass Ø	Glass h	Pc	Colour code
014G	4550010	110 mm	70 mm	16	yellow
015G	4550012	87 mm	70 mm	25	blue
016G	4550014	72 mm	70 mm	36	white
017G	4550016	60 mm	70 mm	49	red
018G	4550018	52 mm	70 mm	64	green

Compartmented heightening frame	Code	Glass Ø	Pc	Colour
024G	4550022	110 mm	16	yellow
025G	4550024	87 mm	25	blue
026G	4550026	72 mm	36	white
027G	4550028	60 mm	49	red
028G	4550030	52 mm	64	green

Compartment basket with one heightening frame	Code	Glass Ø	Glass h	Pc	Colour code
014G-1-024G	4550032	110 mm	120 mm	16	yellow
015G-1-025G	4550034	87 mm	120 mm	25	blue
016G-1-026G	4550036	72 mm	120 mm	36	white
017G-1-027G	4550038	60 mm	120 mm	49	red
018G-1-028G	4550040	52 mm	120 mm	64	green

Compartment basket with two heightening frames	Code	Glass Ø	Glass h	Pc	Colour code
014G-2-024G	4550042	110 mm	170 mm	16	yellow
015G-2-025G	4550044	87 mm	170 mm	25	blue
016G-2-026G	4550046	72 mm	170 mm	36	white
017G-2-027G	4550048	60 mm	170 mm	49	red
018G-2-028G	4550050	52 mm	170 mm	64	green

Compartment basket with three heightening frames	Code	Glass Ø	Glass h	Pc	Colour code
014G-3-024G	4550052	110 mm	220 mm	16	yellow
015G-3-025G	4550054	87 mm	220 mm	25	blue
016G-3-026G	4550056	72 mm	220 mm	36	white
017G-3-027G	4550058	60 mm	220 mm	49	red
018G-3-028G	4550060	52 mm	220 mm	64	green



Ridged compartments – no water-marks – no polishing.



Compartmented heightening frame



Compartment basket is ideal to prevent breakage and scratches during washing, transporting and storing glasses and cups.



Compartment basket for glasses with two heightening frames. Note that compartments and frames are very firmly fixed to the basket. For easy handling it is important that the heights of glasses and the basket are as carefully aligned as possible.

NORDIEN-SYSTEM DISHWASHING BASKETS 500 x 500 mm



Cover for baskets to protect the goods during storage and transport.

Product		Code
Cover for baskets 119	plastic, white	4550062
Drip tray 135	height 50 mm	4550064
Cover grid 154	rilsan coated steel, blue	3054759
Insert for containers 155	stainless steel wire	4550070
Tray grid	stainless steel wire	4550071

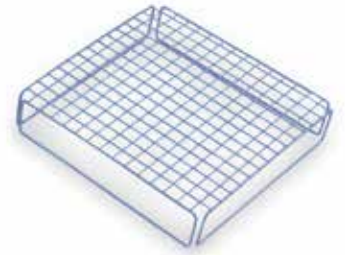

Cover grid to be used when washing lightweight items.



Insert for containers for washing containers and lids placed on edge.

Half basket for cups and glasses 250x500 mm	Code
Plastic, white	4119871



Tray grid



Stainless steel drip tray used with trolleys and tables to prevent dripping on the floor and on table cloths.



Half basket for cups and glasses can be used for example with serving trolley Metos WST Mini.

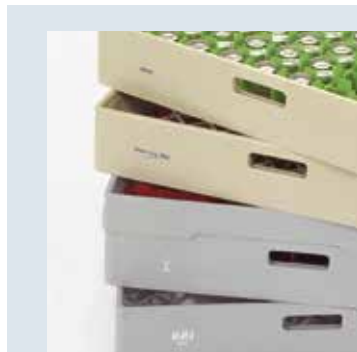

BASKET PRINTING

By a unique system, we can offer printing/coding of baskets. The printing/coding can indicate different glasses, own logo or address and is available in different colours. The printing/coding is ideal for catering and large banquet operations as well as for small restaurants with a large variety of glasses.

Ask for options.



Plate cassettes are colour coded.

PLATE CASSETTES

The cassettes are used in all handling and storage of clean and dirty crockery. They protect the edges of the crockery from becoming chipped during transport and they drastically reduce the crockery breakage. The cassettes can be used in hot cupboards, max 50°C and washed in a dishwashing machine. Height: 30 cm. Made of coated steel wire. Available in eleven sizes.



We can also supply custom-er adapted plate cassettes on request.

Plate cassettes	Code	Plate Ø	Pcs	Colour
126	4550076	12 cm	45	blue
127	4550078	13 cm	45	black
128	4550080	15 cm	45	pink
129	4550082	17 cm	35	grey
130	4550084	19 cm	30	yellow
131	4550086	22 cm	25	red
132	4550088	25 cm	25	white
133	4550090	28 cm	20	red/white
133A	4550092	32 cm	15-20	black/yellow

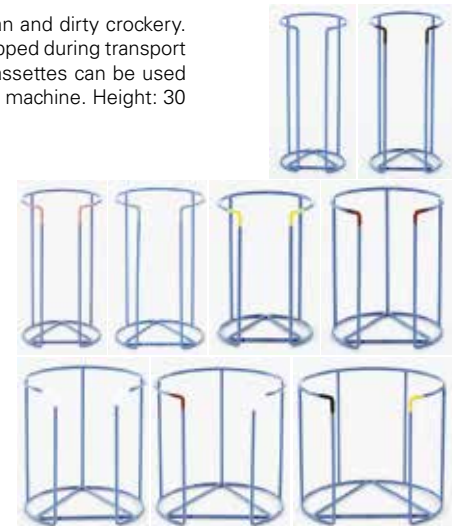

THE ONLY DISHWASHING BASKET DEVELOPED WITH THE SERVING STAFF IN MIND

A **glass basket** spends more than 99 % of its time outside the dishwashing machine; that is why it should not be constructed solely for that purpose. Only Nordien-System has paid attention to that fact. For more than 30 years the 460 mm basket system has been developed and improved in closed co-operation with operators all over the world.

Thanks to the smaller dimension of the 460 mm basket, together with round corners and soft edges, the serving staff can carry the basket on their arm, at the same time putting glasses on the tables. The smart construction and the colour options make it possible to use the basket within the restaurant and bar areas.

The 460 mm baskets are ideal in the storage area. The low sides not only enable easy identification but also give a much larger storage capacity as the distance in height between the baskets can be reduced to a minimum and still give easy access to the glasses. The low sides drastically reduce the breakages in the handling-in area.

When the 460 mm basket goes through the dishwashing machine it is placed in an open dish-washing basket (500 mm). When Nordien-System open 500 mm baskets are used the 460 mm basket can be placed tilted for optimum wash and dry result.

1 Dirty goods are being picked up from the tables and carried out to the dishwashing area.

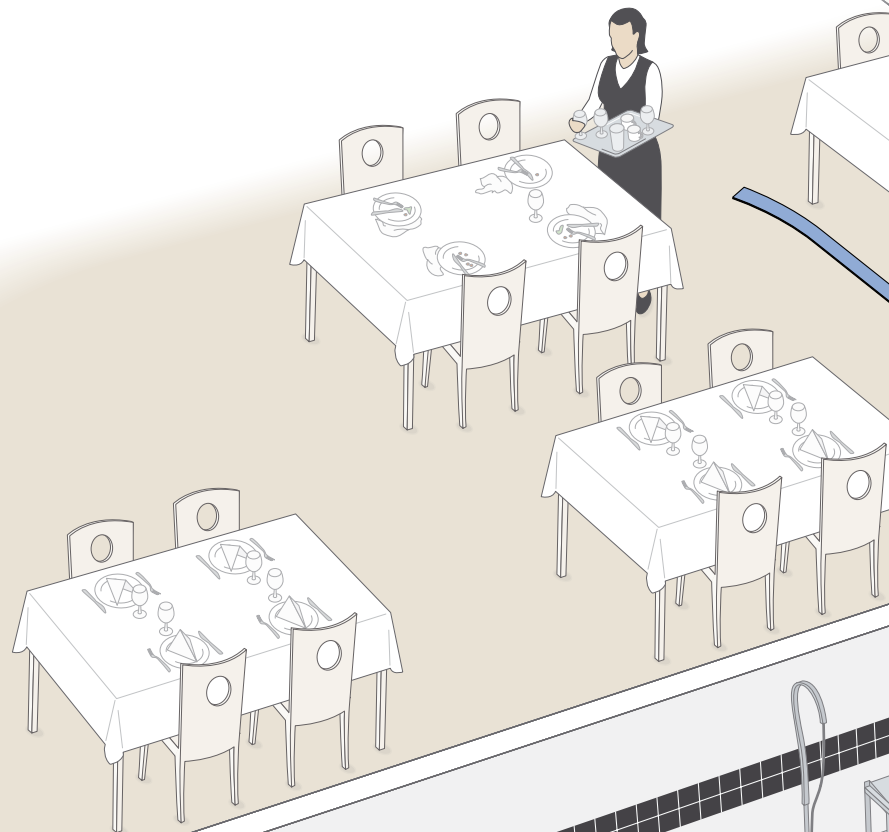

6 The dishwashing process.



7 Dripping/drying.

The container baskets (in which the 460 x 460 mm baskets are to be placed) are only used in the dishwashing machine. The empty container baskets can be stored under the drying line.

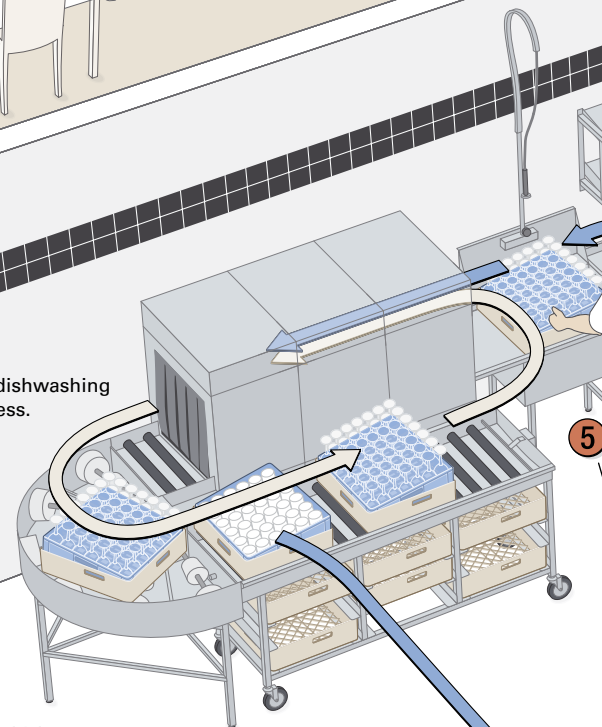

NORDIEN-SYSTEM DISHWASHING BASKETS 460 x 460 mm

The advantages of the 460 mm system:

- User friendly for both serving and stewarding staff
- Less weight
- Available in 11 different glass compartment diameters for the majority of glasses to fit exactly, minimizing the need for high baskets
- Available in a high version for tall glasses when the diameter of the foot is larger than the bowl
- Coded with different colour codes for each individual compartment size
- Ridged compartments no water marks on the glasses no polishing
- The goods are washed tilted for the best washing and drying result without reduced capacity
- The baskets are washed in a container basket and therefore remain undamaged and unscratched
- Less space required for empty baskets
- A complete system with baskets, trolleys, shelving and tabling
- Used worldwide

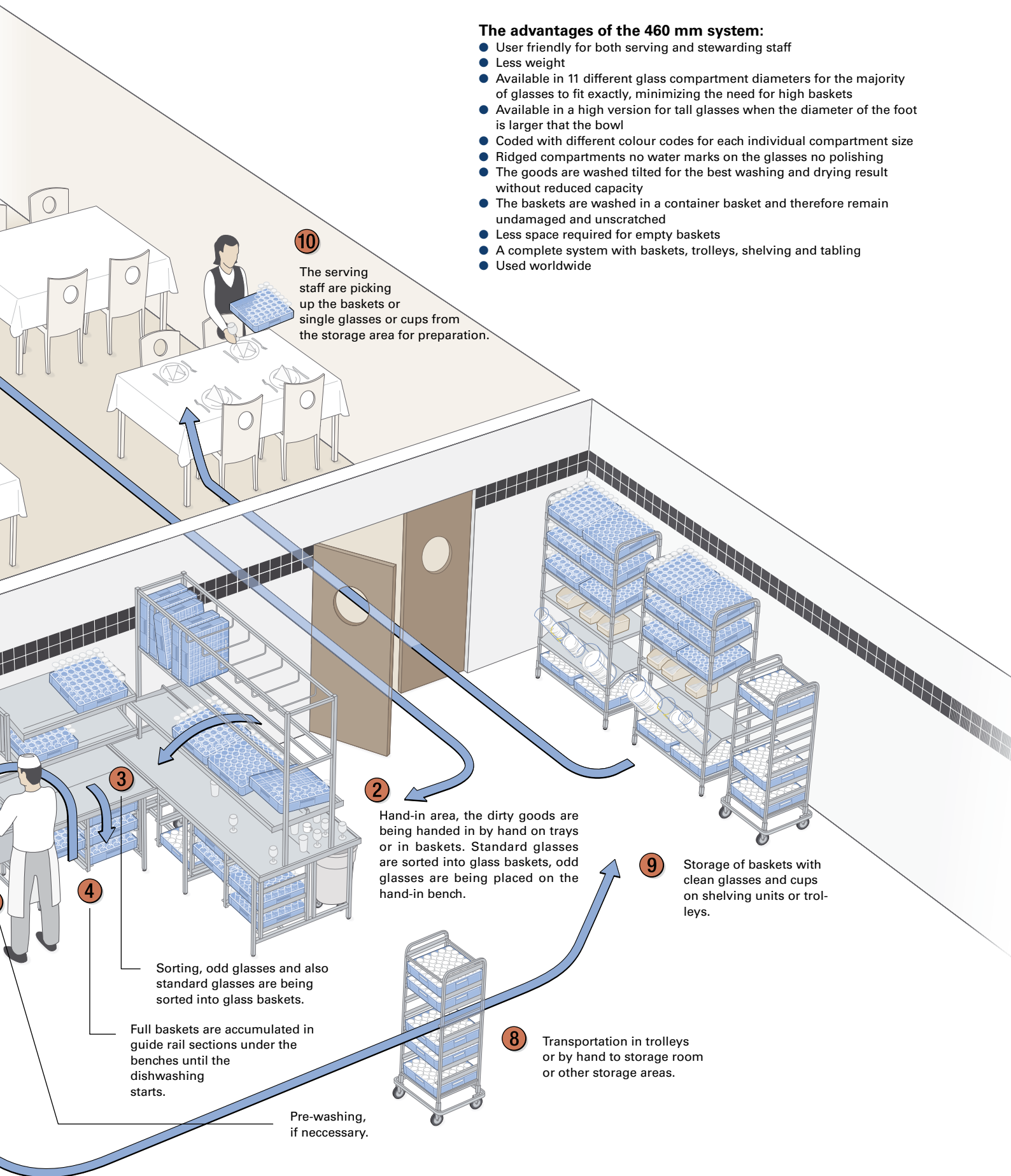

10 The serving staff are picking up the baskets or single glasses or cups from the storage area for preparation.

2 Hand-in area, the dirty goods are being handed in by hand on trays or in baskets. Standard glasses are sorted into glass baskets, odd glasses are being placed on the hand-in bench.

3 Sorting, odd glasses and also standard glasses are being sorted into glass baskets.

4 Full baskets are accumulated in guide rail sections under the benches until the dishwashing starts.

Pre-washing, if necessary.

8 Transportation in trolleys or by hand to storage room or other storage areas.

9 Storage of baskets with clean glasses and cups on shelving units or trolleys.

NORDIEN-SYSTEM DISHWASHING BASKETS 460 x 460 mm

- For glasses and cups
- Small dimension with large capacity.
- Light weight – easy handling
- Prior to being placed in the dishwashing machine they are placed at an angle into a 500 x 500 mm basket
- Ridges in the compartments for optimum drying result
- Injection moulded polypropylene



Compartment basket for glasses and cups The ideal basket for washing, carrying and storing glasses. Each glass is placed in a compartment to prevent breakage and scratches.

The unique 460 mm compartment basket system from Nordien-System is today used throughout the world. Thanks to its light weight and reduced size (460x460 mm), the serving staff can support the basket on the arm when laying up tables. As the compartment basket is placed in an open 500x500 mm basket for washing it will remain as new without scratches and can therefore also be used in bars and other guest areas. The angle of the basket during washing means that a perfect washing result is obtained and the drying is speeded up.



High compartment baskets are for glasses with a larger foot than bowl or very tall glasses.



The picture shows the angle of the basket during washing.

Baskets are colour coded to indicate the glass diameter.

Compartment basket for glasses and cups, blue

	Code	Glass Ø	Glass h	Pc	Colour code
106	4550094	46 mm	85 mm	81	black
107	4550096	52 mm	85 mm	64	green
108	4550098	56 mm	85 mm	49	grey
109	4550100	60 mm	85 mm	49	pink
110	4550102	65 mm	85 mm	36	red
111	4550104	72 mm	85 mm	36	white
112	4550106	76 mm	85 mm	25	red/yellow
113	4550108	81 mm	85 mm	25	yellow
114	4550110	87 mm	85 mm	25	not coded
115	4550112	95 mm	85 mm	16	white/red
116	4550114	110 mm	85 mm	16	pink/grey
117	4550116	149 mm	85 mm	9	black/white

Ordered in sets of 8 baskets.

High compartment baskets are for glasses with a larger foot than bowl or very tall glasses. When ordering, please state height of glass and the diameter of foot if it is greater than that of the bowl.



Open basket

Open basket	Code	
103	4550126	blue, height 85 mm
Drip tray for 460 x 460 baskets	Code	
134	4550128	height 50 mm



Drip tray in stainless steel, used with trolleys and tables to prevent dripping on the floor and on table cloths.

CUTLERY HANDLING



Dishwashing tray for cutlery in stainless steel is also suitable for sterile washing.



Dishwashing tray for cutlery in polypropylene.

Dishwashing tray for cutlery

	Code	Material	Size mm	Height mm	Pcs
120	4550130	stainless steel	340x160	130	100-150
121	4550132	polypropylene	490x180	140	150-200

For soaking and washing cutlery. The dishwashing tray is placed inside basket (code 4550000) when washing.

	Code	Material	Size Ø	Height mm	Pcs
118	4550134	polypropylene	110	130	40-50

For cutlery on server counters and in kitchens. The cutlery cylinder is placed inside basket (code 4550010) when washing.



Cutlery box for clean cutlery

	Code	Colour	Size mm	Height mm	Pcs
123	4550136	grey	160x290	130	80-120
123B	4550138	blue	160x290	130	80-120
123G	4550140	green	160x290	130	80-120
123R	4550142	red	160x290	130	80-120
123W	4550144	semi-white	160x290	130	80-120
123Y	4550146	yellow	160x290	130	80-120
124	4550148	brown	160x290	130	80-120
125	4550150	beige	160x290	130	80-120

Material polypropylene

Lid for cutlery box

	Code	Material	Description
156	4550153	plexiglass	cover for cutlery box

Lid can easily be put on and taken off. It protects the cutlery against dust and dirt and encourages guests and staff to take the cutlery by the handles.



The cutlery cylinders are placed inside compartment basket when washing.

	Code	Size	Height
151	4550154	350x295 mm	320 mm

To hold four Nordien-System's cutlery boxes. Stainless steel.

	Code	Capacity	Length
152-2	4550160	for 2 boxes	330 mm
152-3	4550162	for 3 boxes	500 mm
152-4	4550164	for 4 boxes	660 mm

Material stainless steel.



Stand for cutlery boxes

	Code	Size	Height
152	4554710	460x460 mm	50 mm

Divider bars to the cutlery basket. The basket is not included in the price.



The trused frame consist of two bars. The sections are adjustable. The basket to be ordered separately.



Stainless steel wall bracket for cutlery boxes



NORDIEN-SYSTEM KITCHEN TROLLEYS

Nordien-System kitchen trolley assortment provides trolleys for every purpose. The trolleys are sturdy and designed for every day use. All trolleys have stainless steel construction completed with polypropylene guide rails, in trolleys for GN containers also guide rails are steel. The guide rails have basket stops to prevent sliding while moving trolley.

The trolleys are light to push. All trolleys are fitted with ball bearing wheels, two with brakes. Wheel diameter 125 or 75 mm.

Many trolleys are available with options, such as fender to reduce the crockery breakage. Options are to be ordered at the same time with trolley.

Some trolleys have useful accessories to facilitate working, for example additional shelves for basket trolleys.



FLAT PACK

Most trolleys are available as FLAT PACK versions, which means that trolleys are delivered flat packed unassembled. The trolleys are easy and quick to assemble with instructions and tool included. Small size makes FLAT PACK -models beneficial when transporting.



Flat pack models are easily assembled with instructions and tool included.



The optional fender (to be ordered together with the trolley, not available for flat pack models) makes trolleys resilient and strong.



TROLLEYS FOR GN CONTAINERS



GNT-7 GN container trolley with s/s top shelf.

Nordien-System GN container trolleys can be used to facilitate food preparation, storage and transportation. The trolley construction is sturdy and of stainless steel throughout. The trolleys are fitted with 125 mm ball bearing wheels, two with brakes. The guide rails have basket stops to prevent the containers sliding.

Accessory: s/s top shelf with noise insulation

The GNT-7 trolley has capacity of 7 pcs GN1/1 containers and the GNT-14 trolley 14 pcs GN1/1 containers. Guide rail interval is 75 mm. GNT-12 trolley has capacity of 12 pcs GN1/1 containers and the GNT-24 24 pcs. Guide rail interval is 105 mm.



GNT-14 GN container trolley with s/s top shelf.

Product	Code	Dimensions mm
GNT-7	4554278	410x588x857
GNT-14	4554280	770x588x857
GNT-12	4554282	410x588x1591
GNT-24	4554284	770x588x1591

Accessories	Code	Dimensions mm
S/s top shelf GNT-7/12	4554182	385x565x70
S/s top shelf GNT-14/24	4554184	750x565x70

Flat pack	Code	Package dimensions mm
FP GNT-7	4554374	1255x610x153
FP GNT-14	4554376	1255x610x153
FP GNT-12	4554378	1775x610x153
FP GNT-24	4554380	1775x610x153



Stainless steel top shelf for GNT-14/24 trolleys.



GNT-12 GN container trolley.



GNT-24 GN container trolley.



SHT-90 shelf trolley.



SHT-75 shelf trolley.

SHELF TROLLEYS

Nordien-System SHT-75 shelf trolley is sturdy and of stainless steel throughout. Shelves have a rounded profile rim and noise insulation underneath. Model SHT-90 has plastic grid shelves and stainless steel body. The trolleys are fitted with 125 mm ball bearing wheels, two with brakes. Shelf interval 370 mm. Maximum load 120 kg.

Product	Code	Dimensions mm	Shelves mm
SHT-75	4554286	765x585x1570	4 pcs 730x550
SHT-90	4554288	970x480x1570	4 pcs 900x450

Flat pack	Code	Package dimensions mm
FP SHT-75	4554382	1775x610x153 + 1480x645x380
FP SHT-90	4554384	1775x610x153

SERVICE TROLLEYS



SET-70/2 service trolley.

Nordien-System service trolley with push-handle is sturdy and of stainless steel throughout. Tiers have a rounded profile rim and noise insulation underneath. The trolleys are fitted with 125 mm ball bearing wheels, two with brakes. Maximum load of 2-tiered trolleys is 80 kg and that of 3-tiered 120 kg.

Option: fender

Accessory: S/S waste bin 2x11 litres with holder and plastic buckets included

Two tiers, interval 495 mm

Product	Code	Dimensions mm	Tiers mm
SET-70/2	4554290	685x485x800*	2 pcs 650x450
SET-75/2	4554292	765x585x800*	2 pcs 730x550
SET-105/2	4554294	1120x585x800*	2 pcs 1085x550

*handle height 900 mm

Three tiers, interval 230 mm

Product	Code	Dimensions mm	Tiers mm
SET-75/3	4554296	765x585x800*	3 pcs 730x550
SET-105/3	4554298	1120x585x800*	3 pcs 1085x550

*handle height 900 mm

Options	Code	Dimensions mm
Fender SET-70*	4554172	740x540
Fender SET-75*	4554174	820x640
Fender SET-105*	4554176	1175x640

*to be ordered with trolley

Accessory	Code	Dimensions mm
S/S waste bin 2x11 litres*	4554190	holder and plastic buckets included
Flat tier SET-70	4554173	
Flat tier SET-75	4554175	

*photo on page 16

Flat pack	Code	Package dimensions mm
FP SET-70/2	4554386	1480x645x380
FP SET-75/2	4554388	1480x645x380
FP SET-105/2	4554390	1480x645x380
FP SET-75/3	4554392	1480x645x380
FP SET-105/3	4554394	1480x645x380



SET-75/2 service trolley.



SET-75/3 service trolley.



SET-105/3 service trolley.

SERVICE TROLLEYS WITHOUT HANDLE

Nordien-System service trolley is sturdy and of stainless steel throughout. Tiers have a rounded profile rim and noise insulation underneath. Tier interval is 495 mm, in high models 595 mm. The trolleys are fitted with 125 mm ball bearing wheels, two with brakes. Maximum load 80 kg.

Option: fender

Accessory: S/S waste bin 2x11 litres with holder and plastic buckets included

Height 800 mm, tier interval 495 mm

Product	Code	Dimensions mm	Tiers mm
SET-75WH/2	4554300	765x585x800	2 pcs 730x550

High model, height 900 mm, tier interval 595

Product	Code	Dimensions mm	Tiers mm
SET-75WH/2high	4554302	765x585x900	2 pcs 730x550

Option

Code	Dimensions mm
Fender SET-75*	820x640

*to be ordered with trolley

Accessory

Code	Dimensions mm
S/S waste bin 2x11 litres*	holder and plastic buckets included
Flat tier SET-75	4554175

*photo on page 16

Flat pack

Code	Package dimensions mm
FP SET-75WH/2	1480x645x380
FP SET-75WH/2high	1480x645x380

SET-75WH/2 service trolley with a fender.



SET-70/2 wooden service trolley.

SERVICE TROLLEYS WITH BEECH TIERS

Nordien-System service trolley is sturdy and it has stainless steel body. Tiers are of copper beech and fitted with a profile rim of 2 cm. The tier interval of 2-tiered trolleys is 485 mm and that of 3-tiered 220 mm. The trolleys are fitted with ball bearing wheels, two with brakes. Maximum load 80 kg.

Product	Code	Dimensions mm	Tiers beech mm
SET-70/2wooden	4554304	710x445x800*	2 pcs 640x430
SET-70/3wooden	4554306	710x445x800*	3 pcs 640x430

*handle height 900 mm

Flat pack

Code	Package dimensions mm
FP SET-70/2wooden	1480x645x380
FP SET-70/3wooden	1480x645x380

SET-70/3 wooden service trolley.



KINDERGARTEN TROLLEYS

Nordien-System handled kindergarten trolley is sturdy and of stainless steel throughout. Tiers have a rounded profile rim and noise insulation underneath. Tier interval is 300 mm. The handle is at a height of 800 mm. The trolleys are fitted with ball bearing wheels, two with brakes. Maximum load 80 kg.

Product	Code	Dimensions mm	Tiers mm
SET-75/2low	4554308	765x585x600*	2 pcs 730x550

*handle height 800 mm

Flat pack

Code	Package dimensions mm
FP SET-75/2low	1480x645x380



SET-75/2low kindergarten trolley.

BASKET TROLLEYS FOR 500x500 mm BASKETS



BAT-8 basket trolley with a fender, s/s top shelf and s/s drip tray.



BAS-3 counter top basket rack.



The Dolly without and with handle.

Nordien-System basket trolleys for transporting and storing baskets are sturdy, stable and long lasting. Frames are of stainless steel complete with polypropylene guide rails. The guide rails have basket stops to prevent the baskets sliding. The trolleys are fitted with 125 mm ball bearing wheels, two with brakes.

Option: fender
Accessories: Water drip tray, s/s shelf and s/s top shelf

Product	Code	Dimensions mm	Baskets/guide rail distance
BAT-4	4554310	590x590x832	4 baskets/ 160/120mm
BAT-5	4554312	590x590x1072	5 baskets/ 160 mm
BAT-6high	4554480	590x590x1591	6 baskets/ 228 mm
BAT-8	4554314	590x590x1591	8 baskets/ 160 mm

Option	Code	Dimensions mm
Fender BAT*	4554164	645x645

*to be ordered with trolley

Accessories	Code	Dimensions mm
Water drip tray	4550064	510x510x50
S/S shelf	4554160	510x560x35
S/S top shelf	4554528	565x565x70

Flat pack	Code	Package dimensions mm
FP BAT-4	4554406	1255x610x153
FP BAT-5	4554408	1255x610x153
FP BAT-6high	4554482	1775x610x153
FP BAT-8	4554410	1775x610x153



BAT-4 basket trolley with a fender.



The water-drip tray placed on a basket trolley's lower runners prevents the floor from getting wet and dirty.

BASKET SERVICE TROLLEY

Nordien-System basket service trolley for self service counters etc. Capacity is six baskets. The two upper guide rail sets are angled for easy access to cups and glasses. Frames are of stainless steel complete with polypropylene guide rails. The guide rails have basket stops to prevent the baskets sliding. The trolleys are fitted with 125 mm ball bearing wheels, two with brakes.

Option: fender
Accessories: Water drip tray, s/s shelf

Product	Code	Dimensions mm	Baskets/guide rail distance
BAT-6	4554316	590x590x1596	6 baskets/195 mm

Option	Code	Dimensions mm
Fender BAT*	4554164	645x645

*to be ordered with trolley

Accessories	Code	Dimensions mm
Water drip tray	4550064	510x510x50
S/S shelf	4554160	510x560x35

Flat pack	Code	Package dimensions mm
FP BAT-6	4554412	1775x610x153

Counter top basket rack	Code	Dimensions mm	Baskets/guide rail distance
BAS-2	4554156	560x560x617	2 /195 mm
BAS-3	4554154	560x560x870	3 /195 mm



BAT-6 service trolley.

BASKET DOLLY

Nordien-System basket dolly for transporting dishwashing baskets. Trolley and handle of stainless steel. The trolleys are fitted with 125 mm ball bearing wheels, two with brakes.

Product	Code	Dimensions mm	
Dolly	4554346	520x520x205	without handle
Dolly	4554348	565x580x920	with handle

DISPENSER TROLLEYS



TDT tray dispenser trolley.



Holder for cutlery boxes for TDT and RDT. Cutlery boxes are not included in the delivery.

Nordien-System dispenser trolley is used in serving lines for storing glass baskets or trays. The basket dispenser trolley has capacity of five baskets, the tray dispenser trolley approximately 70 trays. The new spring mechanism brings the serving platform always to the right height. The trolleys are of stainless steel. The trolleys are fitted with 75 mm ball bearing wheels, two with brakes.

Option: push-handle
Accessory: holder for plastic cutlery boxes

Product	Code	Dimensions mm
RDT basket dispenser	4554318	515x645x975
TDT tray dispenser	4554320	400x645x975

Options	Code	
Handle*	4554198	handle height 900 mm

*to be ordered with trolley

Accessory	Code	
Holder for cutlery boxes	4554192	1200 mm*

*height including cutlery boxes

Nordien-System TCT tray and cutlery trolley is sturdy and of stainless steel. Capacity is approx. 100/200 trays. The shelf has a rounded profile rim and noise insulation underneath. The trolleys are fitted with 125 mm ball bearing wheels, two with brakes. The TCT-45 model is fitted with two plastic cutlery boxes, TCT-75 model with four boxes.

Accessories: stainless steel shelf, napkin dispenser

Product	Code	Dimensions mm	Capacity
TCT-45	4554322	425x590x1061	100 pcs
TCT-75	4554324	765x590x1061	200 pcs

Accessories	Code	Dimensions mm
S/S shelf TCT-45	4554186	350x285x60
S/S shelf TCT-75	4554188	690x285x60
Napkin dispenser	4554189	450x320x140

Flat pack	Code	Package dimensions mm
FP TCT-45	4554414	1255x610x153
FP TCT-75	4554416	1255x610x153



RDT basket dispenser trolley with a cutlery box holder.



TCT-75 tray and cutlery trolley.



Hanging napkin dispenser to TCT trolley.

PLATE CASSETTE TROLLEYS

Nordien-System plate cassette trolleys for transport and storage of plates in plate cassettes. Sturdy stainless steel construction. The trolleys are fitted with 125 mm ball bearing wheels, two with brakes.

Option: fender

Product	Code	Dimensions mm	Capacity/shelf interval
PCT-4	4554325	765x415x900	4 cassettes/ Ø475 mm
PCT-6**	4554326	1010x415x900	6 cassettes/ Ø475 mm
PCT-8	4554328	765x630x900	8 cassettes/ Ø475 mm
PCT-12	4554330	765x630x1300	12 cassettes/ Ø425mm
PCT-12 low	4554532	1010x630x900	12 cassettes/ Ø425mm

Options	Code	Dimensions mm
Fender PCT-4*	4554524	820x470
Fender PCT-6*	4554168	1065x470
Fender PCT-8/12*	4554166	820x685
Fender PCT-12low*	4554534	1065x685

Flat pack	Code	Package dimensions mm
FP PCT-4	4554522	1480x645x380
FP PCT-6**	4554418	1480x645x380
FP PCT-8	4554420	1480x645x380
FP PCT-12	4554422	1480x645x380
FP PCT-12 low	4554530	1480x645x380

*to be ordered with trolley **one-sided



Double sided plate cassette trolley PCT-12 with steel wheels.



Plate cassette trolley PCT-6 with a fender.

DISH RETURN TROLLEYS AND COMBINATION TROLLEYS

Well organized return of dishes increases customer satisfaction and facilitates the work of kitchen staff. The versatile range of return trolleys enables effective return arrangements even when space is limited.

Nordien-System dish return trolley is sturdy and of stainless steel throughout. The trolleys are fitted with 125 mm ball bearing wheels, two with brakes. Two shelves, tray slide and holder for cutlery boxes including 4 plastic cutlery boxes.

Accessory: waste bin (holder and plastic buckets included)

Product	Code	Dimensions mm	Shelves mm
COT-75	4554332	765x585x800/1300	2 pcs 730x550
COT-75low	4554334	765x585x800/1100	2 pcs 730x550

Accessory	Code	Dimensions mm
S/S waste bin 2x11 litres	4554190	370x270x325

Flat pack	Code	Package dimensions mm
FP COT-75	4554424	1480x645x380
FP COT-75low	4554426	1480x645x380



On the left COT-75 dish return trolley with a s/s waste bin and on the right BAT-4 basket trolley.



Stainless steel waste bin 2x11 litres, holder and buckets included.



Tray holder for COT-110 and COT-282.



Holder for cutlery tray for COT-110.



Angled plate cassette shelf for COT-110.

Nordien-System combination trolley for many uses such as dish return, laying and clearing tables. Stainless steel construction throughout. The trolley is fitted with 125 mm ball bearing wheels, two with brakes. The trolley capacity is five 500 mm or 460 mm baskets. Guide rail distance is 165 mm. Guide rails have basket stops to prevent the baskets sliding. On the right hand side there is a plain shelf as standard, optionally angled plate cassette shelf.

Option: fender

Accessories: additional shelf, tray holder, waste bin (incl. holder and lid), water drip tray, holder for cutlery tray.



COT-110 combination trolley with tray holder, holder for cutlery tray, waste bin and fender.

Product	Code	Dimensions mm
COT-110	4554336	1128x590x1089

Option	Code	Dimensions mm
Fender COT-110	4554170	to be ordered with trolley 1185x645

Accessories	Code	Dimensions mm
Plate cassette shelf	4554178	to the right side of trolley 515x560x180
Additional shelf	4554160	to the left side of trolley 510x560x35
Tray holder	4554180	to the left/right side of trolley 570x280x310
Waste bin and holder	4554442	to the left side of trolley 540x210x125
Holder for cutlery tray	4554200	to the left/right side of trolley 540x210x125
Water drip tray	4550064	to the left side of trolley 510x510x50

Flat pack	Code	Package dimensions mm
FP COT-110	4554428	1480x645x380

DISH RETURN TROLLEYS AND COMBINATION TROLLEYS

Nordien-System compact combination trolley for many uses such as laying and clearing tables. Stainless steel construction throughout. The trolley is fitted with 125 mm ball bearing wheels, two with brakes. The capacity is three 500 mm or 460 mm baskets, guide rail distance is 165 mm. Guide rails have basket stops to prevent the baskets sliding.

Accessories: tray holder, waste bin, waste bin holder, water drip tray

Product	Code	Dimensions mm
COT-282	4554338	1120x585x800*

*handle height 900 mm

Accessories	Code	
Tray holder	4554180	570x280x310
Waste bin holder	4554642	inc. two 10 l waste bins
Waste bin 2x10 l	4554646	10 l
Water drip tray	4550064	510x510x50

Flat pack	Code	Package dimensions mm
FP COT-282	4554430	1480x645x380



COT-282 combination trolley

DEPARTMENT SERVING TROLLEY



WST Mini with optional side shelf, waste bin holder, hand sanitizer holder and top shelf.

Nordien-System department serving trolley has been developed to assist food distribution for instance in a hospital ward. Patient trays are finalized on the trolley by adding cutlery, serviette, etc. Or it can serve as station for afternoon coffee or tea. Trolleys are made of stainless steel. Ball bearing plastic wheels with brakes, diameter 125 mm.

Uniform working platform with ergonomic height. Under the platform there are pull-out tray slides (1 pc WST Mini, 2pcs WST Std/Flex) on both sides and room for 500 x 500 baskets. WST Mini has 2 pairs of pull out guide rails for baskets, WST Std model has 2 + 2 pairs of plastic guide rails for baskets, WST Flex model 2 + 2 pairs of pull out guide rails. Above the trolley on the top frame there is room for GN 1/4 or GN 1/2 containers. Accessories: holder for three 11 liter waste bins, s/s waste bin 2 x 11 liter, plastic side shelf, hand sanitizer holder and a detachable shelf for top frame.

Product	Code	Dimensions mm
WST Mini	4554628	000x000x000
WST Std	4554550	1150x560x1300
WST Flex	4554552	1150x560x1300

Accessories	Code	
Waste bin holder	4554553	3x11 liter
S/s waste bin	4554554	2x11 liter
Down-fold side shelf	4554555	plastic
Hand sanitizer holder	4554556	
Shelf to top frame	4554557	450 mm

TRAY RETURN TROLLEYS



TRT-10 tray return trolley.

Nordien-System tray return trolleys as single or double models. Standard tray size 430-530 x 325 mm. Frames are of stainless steel complete with polypropylene guide rails. Guide rail distance 125 mm, capacity 10 or 20 trays. Guide rails have tray stops to prevent the trays sliding. The trolleys are fitted with 125 mm ball bearing wheels, two with brakes. Other tray sizes on request.

Accessory: s/s shelf on to top of the trolley or to lower guide rails

Product	Code	Dimensions mm	Trays
TRT-10	4554340	410x590x1591	10 pcs 430-530x325 mm
TRT-20	4554454	775x590x1591	20 pcs 430-530x325 mm

Accessories	Code	Dimensions mm
S/S shelf	4554158	330x560x35
Fender TRT-10*	4554165	464x642
Fender TRT-20*	4554167	826x642

* to be ordered with trolley

Flat pack	Code	Package dimensions mm
FP TRT-10	4554432	1775x610x153
FP TRT-20	4554458	1775x610x153



Stainless steel shelf.

TRAY RETURN TROLLEYS WITH LAMINATED COVERS



TRT-10C tray return trolley with s/s shelf on top.

Nordien-System tray return trolleys as single or double models. Standard tray size 430-530 x 325 mm. Frames are stainless steel complete with polypropylene guide rails. Guide rail distance 125 mm, capacity 10 or 20 trays. Guide rails have tray stops to prevent the trays sliding. The trolleys are fitted with 125 mm ball bearing wheels, two with brakes. Other tray sizes on request.

Standard colours for laminated covers are gray and beech. Other materials on request.

Accessory: s/s shelf on to top of the trolley or to lower guide rails



TRT-20C tray return trolley with s/s shelves on top.

Product	Code	Dimensions mm	Trays
TRT-10C	4554342	410x590x1591	10 pc 430-530 x 325 mm
TRT-20C	4554344	775x590x1591	20 pc 430-530 x 325 mm

Accessories	Code	Dimensions mm
S/S shelf	4554158	330x560x35
Fender TRT-10*	4554165	464x642
Fender TRT-20*	4554167	826x642

* to be ordered with trolley

Flat pack	Code	Package dimensions mm
FP TRT-10C	4554434	1775x610x153
FP TRT-20C	4554436	1775x610x153

MULTIPURPOSE TROLLEY

Nordien-System multipurpose trolley can be used as container support when emptying kettles and peeling machines, to take the output of vegetable slicers etc. Unnecessary transfers are thus avoided. Adjustable GN runners, heights 450, 550, 650, 750 and 850 mm. Construction stainless steel throughout. The trolley is fitted with 75 mm ball bearing wheels, two with brakes. GN containers are optional.

Product	Code	Dimensions mm	Capacity	GN
MPT-450	4554354	570x400x1040	60 kg	GN1/1
MPT-2/450	4554355	590x720x1040	80 kg	GN2/1



MPT-450 multipurpose trolley.



MPT2-450 multipurpose trolley.

TRANSPORT TROLLEY

Nordien-System platform trolley is sturdy stainless steel throughout. The PFT-67 trolley is fitted with 125 mm ball bearing wheels (PFT-75 with 75 mm), two with brakes. PFT-67 maximal load capacity is 60 kg and PFT-75 200 kg.

Product	Code	Dimensions mm	Capacity
PFT-67	4554358	730x465x920	60 kg
PFT-75	4554360	820x600x900	200 kg



PFT-67 transport trolley.



PFT-75 transport trolley.

SPICE TROLLEYS



SPT-600 spice trolley

Nordien-System spice trolley conveniently takes spices to the work point. The trolleys are sturdy and stainless steel throughout. Two models. Ball bearing castors, two of castors have brakes.

Product	Code	Dimensions mm	Capacity
SPT-500	4554128	400x475x920	25 pcs Tetra-Pak
SPT-600	4554130	600x550x850	28 pcs Tetra-Pak



SPT-500 spice trolley

FLOUR TROLLEYS



IBI-81 flour trolley

Nordien-System flour trolleys are for storing flour, sugar, rice etc. Easily reached products and convenient space saving storage under table.

Nordien-System JAV flour trolley is tight, sturdy and of stainless steel throughout. Ball bearing castors, of which two equipped with brakes.

Product	Code	Dimensions mm
JAV-100	2026446	480x600x660



JAV-100 flour trolley

Nordien-System IBI flour trolley is white food grade polypropylen, lid is polycarbonate. Lid is easily opened with one hand. Flour scoop has a place under the lid. Four castors, two of them with brakes. Two sizes: 81 and 102 litres.

Product	Code	Dimensions mm
IBI-81	4133246	333x743x711
IBI-102	4133252	394x749x711



IBI-102 flour trolley

LAUNDRY TROLLEY



LAT laundry trolley.

Nordien-System laundry trolley is for collecting soiled linen in restaurants, room service etc. Frames are sturdy stainless steel throughout. The stong cotton sack is suspended to frame with strings. The trolley is fitted with 125 mm ball bearing wheels, two with brakes.

Product	Code	Dimensions mm
LAT	4554362	800x480x910

Flat pack	Code	Package dimensions mm
FP LAT	4554438	1255x610x153

BASIN TROLLEYS

Nordien-System basin trolley is sturdy and of stainless steel throughout. Thanks to seamless construction and rounded corners, the trolley is hygienic and simple to clean. The trolley is fitted with 125 mm ball bearing wheels, two with brakes. Basin capacities are indicated by model numbers. The basin is fitted with a closing valve.



AV-45 basin trolley

Product	Code	Dimensions mm	Basin mm
AV-45	4554600	470x570x800	400x500x250
AV-50	4554602	615x765x800	550x700x140
AV-70	4554604	470x670x800	400x600x300
AV-75	4554606	610x610x700	550x550x250
AV-90	4554608	615x765x800	550x700x250
AV-175	4554610	610x610x720	550x550x550



AV-175 basin trolley



245 cutlery soak trolley with cutlery chute

CUTLERY SOAK TROLLEY

Nordien-System cutlery soak trolley is of stainless steel. A 500x500 mm dishwashing basket fits in it. The trolley is fitted with 125 mm ball bearing wheels, two with brakes. The basin is fitted with a closing valve.

Accessory: cutlery chute, which can be easily removed for cleaning.

Product	Code	Dimensions mm	Basin depth mm
245	4554620	550x550x700	250
263	4554622	cutlery chute	

WASTE TROLLEYS



217 waste trolley.

Nordien-System waste trolley in heavy duty design with rilsan coated handles. Convex bottom for easier emptying and cleaning. Diameter 385 mm and volume 45 litres. Separate stainless steel chassis is fitted with 75 mm ball bearing wheels, two with brakes.

Delivery includes bin and chassis.

Product	Code	Diameter	Height	Volume
217	4551222	Ø 385	615 mm	45 litres



WAB-45 waste bin.

Nordien-System WAB conical waste bin in grey plastic. Diameter and volume: 458 mm/45 liters and 485 mm/65 litres. Separate stainless steel chassis is fitted with 75 mm ball bearing wheels, two with brakes.

Delivery includes bin and chassis.
Accessory: lid

Product	Code	Diameter	Height	Volume
WAB-45	4554366	Ø 458 mm	535 mm	45 l
WAB-65	4554368	Ø 485 mm	580 mm	65 l

Accessories	Code
Lid 45 litres	4554194
Lid 65 litres	4554196



WAB-65 waste bin with a lid.



WAT-60 waste trolley.

Nordien-System WAT waste trolley. Plastic bin with cover. Cover opening ø 150 mm. Platform with push-handle of stainless steel. The trolley is fitted with 75 mm ball bearing wheels, two with brakes. Handle is detachable.

Accessory: 60 l extra plastic bin

Product	Code	Dimensions	Volume
WAT-60	4554370	285x555x660*	60 l
WAT-120	4554372	555x555x660*	2x60 l

*Total height with the plastic bin is 720mm.

Accessory	Code	Dimensions	Volume
WAC-60	4554526	285x555x620	60 l extra plastic bin



WAT-120 waste trolley.

SACK TROLLEY

Nordien-System sack trolley is made of rilsan finished spring steel in a construction that keeps the sack stretched. Colour grey. The trolley is fitted with 75 mm ball bearing wheels, two with brakes.

Product	Code	Dimensions mm	Sack volume
SAT-60	4551250	365x340x750 mm	60 litres
SAT-125	4551248	485x450x800 mm	125 litres



SAT Sack trolley

WASTE TROLLEY TO FIT UNDER DISH RETURN TABLE



Waste trolley.

Nordien-System waste trolley, grey plastic bins. Platform with handle in stainless steel. Four 75 mm ball bearing castors, two with brakes. Two waste bins included.

Product	Code	Dimensions mm
Waste trolley and two bins	4554441	312x470x540

Accessory	Code	Volume
Bin	4554443	20 l

WASTE TROLLEYS AND CUPBOARDS



LBJV-2 waste trolley with tray shelf, two 30 litre bins.

The sorting of kitchen waste has become part of modern waste management. Sorting out organic waste from other waste for composting decreases environmental load. From the range you will find a wide variety of solutions enabling you to link waste management to other kitchen activities.

Nordien-System waste trolleys and cupboards are manufactured of stainless steel. Detachable guide collars and open bottom makes the construction easy to clean. Guide collar diameter is 240 mm, except in model LBJVM-2 the diameter is 180 mm. Cupboard models are fitted with adjustable legs and trolley models with 125 mm ball bearing wheels, two with brakes. A drop-down tray shelf is available as an accessory. The shelf is easy to fit into the mounting holes.

Waste cupboards	Code	Outer dim. mm	Volume
LBJK-1	4208458	400x580x850	30 l
LBJK-2	4208465	800x580x850	2 x 30 l

Waste trolleys	Code	Outer dim. mm	Volume
LBJV-1	4208472	400x580x850	30 l
LBJV-2	4208497	800x580x850	2 x 30 l
LBJVM-2	4208507	400x580x850	2 x 10 l

Accessories	Code		
Tray shelf	4150906	400x250 mm	
Tray shelf	4150977	800x250 mm	
Guide collar	4208627	diam. 240 mm	
Guide collar	4140913	diam. 180 mm	
Plastic waste bin	4150938		30 l
Plastic waste bin	4250010		10 l



LBJV-1 waste trolley with a 30 litre bin.



LBJVM-2 waste trolley with tray shelf, two 10 litre bins.



Open construction, in hygienic stainless steel throughout, does not collect dirt.



Detachable guide collar.

NORDIEN-SYSTEM RACKS FOR 500 x 500 mm BASKETS

Nordien-System service racks are designed to better utilise limited storage space and to reduce the distance for dishwashing, serving and kitchen staff. The racks help to reduce breakages and the staff have more time for efficient work and improved service to guests. All racks are available for 460x460 mm baskets.



901 double



902 single



903 double



904 single



905 double



906 single



907 double



908 single

RESTAURANT RACKS

Restaurant racks have angled shelves for easier access. Available as single and double models.

For glasses				Capacity
500 baskets	Code	Dimensions mm	Shelves	glasses appr.
901 double	4551308	1100x520x1910	6	430
902 single	4551310	590x520x1910	6	210

For glasses/crockery				Glasses/
500 baskets	Code	Dimensions mm	Shelves	plates appr.
903 double	4551312	1100x520x1910	5	300/240
904 single	4551314	590x520x1910	5	150/120

SERVING RACKS

Serving racks are adapted so that serving staff can easily take those items which are needed for laying tables. Available as single and double models.

For glasses/crockery/cutlery				Glasses/plates/
500 baskets	Code	Dimensions mm	Shelves	cutlery appr.
905 double	4551316	1100x520x1910	5	210/350/450
906 single	4551318	590x520x1910	5	100/170/220

For glasses/crockery/cutlery				Glasses/plates/
500 baskets	Code	Dimensions mm	Shelves	cutlery appr.
907 double	4551320	1100x520x1910	6	280/240/900
908 single	4551322	590x520x1910	6	140/120/450

NORDIEN-SYSTEM RACKS FOR 500 x 500 mm BASKETS

The service racks are made in stainless steel square tubing, 20x20 mm. Stainless steel distance tubing and shelves. Grid shelves in polypropylene. Manufactured with adjustable feet. The service racks are very stable. The racks are easily assembled with supplied tools.



909 double



910 single



911 double



912 single



913 double



914 single



915 double



916 single

STORAGE RACKS

Storage racks have large capacity for glasses or cups and crockery or cutlery. Available as single and double models.

For glasses/crockery		Dimensions mm	Shelves	Glasses approx.
500 baskets	Code			
909 double	4551324	1100x520x1910	7	500
910 single	4551326	590x520x1910	7	250

For glasses/crockery/cutlery		Dimensions mm	Shelves	Glasses/plates approx.
500 baskets	Code			
911 double	4551328	1100x520x1910	7	430/240
912 single	4551330	590x520x1910	7	210/120

SERVING RACKS

Service racks with a flat shelf are very suitable for preparation of trays etc. Available as single and double models.

For glasses/crockery/cutlery		Dimensions mm	Shelves	Glasses/plates/cutlery approx.
500 baskets	Code			
913 double	4551334	1100x520x1910	8	210/100/450
914 single	4551334	590x520x1910	8	100/50/220

For glasses/crockery/cutlery		Dimensions mm	Shelves	Glasses/plates/cutlery approx.
500 baskets	Code			
915 double	4551336	1100x520x1910	7	70/480/900
916 single	4551338	590x520x1910	7	30/240/450

CUTLERY SORTING RACK

Nordien-System cutlery sorting rack is specially designed for sorting and storage of cutlery. The work surface has an upstand on three sides which prevents the cutlery from falling onto the floor.

The rack is delivered flat packed and is easily assembled with supplied tools.

Cutlery sorting and storage rack	Code	Dimensions mm	Shelves
917	4551340	1100x520x1910	7
918	4551342	590x520x1910	7



Cutlery sorting rack 917.



Basket storage rack 932.



Basket storage rack 973.

BASKET RACK

Nordien-System storage racks for 12 baskets. Stainless steel frame, guide rails polypropylene with basket stops. Separate models for 500 mm and 460 mm baskets. The rack is delivered flat packed and is easily assembled.

Storage racks for baskets	Code	Dimensions mm	Capacity baskets
500 baskets			
932	4551058	590x520x1910	12
460 baskets			
973	4551092	560x490x1910	12



CLIPS FOR RACKS

Nordien-System clips for racks for connecting racks to each other and making a more stable unit. Stainless steel. With wallclip the racks can be fastened to a wall. Stainless steel.

Clips for racks	Code
wallclip for racks	4551392
clip for racks	4551394

STORAGE RACK



Storage rack 919.

Storage rack 920.

Nordien-System storage racks are ideal for storing crocery in cassettes. Frames are in stainless steel square tubing, 20x20 mm. Stainless steel shelves support heavy loads. Distance between shelves 340 mm. 330 mm or 520 mm deep shelves. Adjustable feet.

The rack is delivered flat packed and it is easily assembled with supplied tools.

Storage rack depth 330 mm	Code	Dimensions mm	Shelves	Plates approx.
919	4551344	1100x330x1910	5	600
920	4551346	590x330x1910	5	300
depth 520 mm				
921	4551348	1100x520x1910	5	1200
922	4551350	590x520x1910	5	600

POT AND PAN RACK

Nordien-System racks for storing pots, pans and containers etc. Frames stainless steel square tubing 20x20 mm, grid shelves stainless steel wire. Distance between shelves 513 mm. Adjustable feet.

The rack is delivered flat packed and is easily assembled with supplied tools.

Pot and pan rack depth 52 cm	Code	Dimensions mm	Shelves
357	4551300	590x520x1910	4
358	4551302	1100x520x1910	4



Pot and pan rack 358.

Pot and pan rack 357.

CRATE RACK

Nordien-System crate rack is designed for collecting empty bottles into crates and for storage of beverages. The crate shelf speeds up the handling of bottles. The rack frames are of stainless steel square tubing, 20x 20 mm. Adjustable feet.

Crate rack	Code	Dimensions mm
360 For eight crates	4551006	960x320x1540
359 For four crates	4551004	510x320x1540

The bottle crate shelf keeps crates firmly in place. Removal and return is fast and effortless.



Crate rack 360.

Crate rack 359.



NORDIEN-SYSTEM CAROUSEL SYSTEM



At lunch or dinner the serving staff are very busy selling and serving food and drinks. This means that depositing of the dirty dishes must be easy and quick. To achieve this, Nordien-System has developed the accumulating principle for hotels and restaurants which works as follows:

The serving staff's work:

1. Place the cutlery in the cutlery soak trolley.
2. Scrape the left overs into the waste bin using the plate scraper.
3. Put the plates, saucers and bowls on the lower level of the carousel.
4. Glasses and cups on the upper level.

The dishwashing staff's work:

5. Sort the glasses and cups into the correct baskets.
Put the full baskets in the guide rail sections under the table.
Empty basket is put on the shelf.
The plates are sorted according to size and are placed in piles on the sorting table.
6. If required, serving dishes can be put into the basin for soaking.
7. When the busiest period is over, the actual washing begins.
The glass baskets are ready to be placed on the basin line for sliding into the dishwasher. Load plate baskets. Finally cutlery will be washed two times first flat and then standing UNSORTED.
8. 180° turn track and roller table return baskets to the dishwashing staff for removal.
9. The baskets are put into basket trolleys and the plates are put into cassettes on a plate cassette trolley for transport to the storage area.
10. In the storage area everything is stored in the correct place so that all staff know where to find specific items. Optimal storage racks give easy access to all goods.

DELIVERY CAROUSEL

Nordien-System delivery carousel: One of Nordien-System's innovations is the delivery carousel. Since the carousel rotates all the time, the serving staff can quickly find space to dump the dirties. At the same time the steward can remain standing in the same place and sort glasses and cups into baskets and plates into piles. A carousel with two levels, diameters 1800+1500 mm is equivalent to a table 5300 mm long and 800 mm deep!



Carousel 810-1H with tray support and sink on right.

The carousel has two levels. Construction is of stainless steel. Motor driven, speed 1.2 revolutions per minute.

Tray support on one side, can be delivered with or without sink. The length is equal to the diameter of the carousel. Depth 450 mm. The tray support for corner includes 45° corner element. Adjustable feet.

Carousel	Code	Diameter mm	Height mm	El.connection
810-2 with tray support	4552358	Ø 1800+1500	1250	230V 1~18W
810-2H with tray support+sink on right	4552360	Ø 1800+1500	1250	230V 1~18W
810-2V with tray support+sink on left	4552362	Ø 1800+1500	1250	230V 1~18W
811-2 with corner tray support	4552372	Ø 1800+1500	1250	230V 1~18W
810-1 with tray support	4552352	Ø 1500+1200	1250	230V 1~18W
810-1H with tray support+sink on right	4552354	Ø 1500+1200	1250	230V 1~18W
810-1V with tray support+sink on left	4552356	Ø 1500+1200	1250	230V 1~18W
811-1 with corner tray support	4552370	Ø 1500+1200	1250	230V 1~18W
810-3 with tray support	4552364	Ø 1200+1000	1250	230V 1~18W
810-3H with tray support+sink on right	4552366	Ø 1200+1000	1250	230V 1~18W
810-3V with tray support+sink on left	4552368	Ø 1200+1000	1250	230V 1~18W
811-3 with corner tray support	4552374	Ø 1200+1000	1250	230V 1~18W

SCRAPER

To scrape left overs from plates to the waste bin below without using hands or cutlery. The scraper can be fitted to most type of tables.



Scraper unit 421.

Scraper unit	Code
421	4551910

Scraper without holder	Code
421A exchange blade	4552136



DELIVERY/SORTING TABLE



A free standing **Nordien-System delivery/sorting table**. Serving staff can deposit dirty dishes while the dishwashing staff are sorting them on the other side. Under the table there are guide rail sections for 500 x 500 mm or 460 x 460 mm baskets.

The table can be supplied with a sorting shelf and an empty basket rack. On sorting shelf baskets can be angled towards either the serving or dishwashing staff. A basket rack is for empty baskets standing on side.

The table and shelves are of stainless steel. Outlet connection on table top. Adjustable feet.

Accessory: tray support, 300 mm deep

Delivery table includes guide rail sections either for 500x500 mm or 460x460 mm baskets are available. Delivery unit includes sorting shelf and empty basket rack. Mobile waste bin, scraper, tray support and cutlery soak trolley are accessories.

Delivery unit consists of guide rail sections, sorting shelf and empty basket rack.

Delivery unit, 500 baskets	Code	Dimensions mm
640-2-50-642-644	4552264	1176x1000x2355 with shelves
640-3-50-642-644	4552266	1719x1000x2355 with shelves
640-4-50-642-644	4552268	2262x1000x2355 with shelves
640-5-50-642-644	4552270	2805x1000x2355 with shelves
640-6-50-642-644	4552272	3356x1000x2355 with shelves

Delivery table includes guide rail sections for 500 baskets.

Delivery table, 500 baskets	Code	Dimensions mm
640-2-50	4552246	1176x1000x875±25
640-3-50	4552250	1719x1000x875±25
640-4-50	4552254	2262x1000x875±25
640-5-50	4552258	2805x1000x875±25
640-6-50	4552262	3356x1000x875±25

Delivery unit consists of guide rail sections, sorting shelf and empty basket rack.

Delivery unit, 460 baskets	Code	Dimensions mm
640-2-46-642-644	4552274	1176x1000x2355 with shelves
640-3-46-642-644	4552276	1719x1000x2355 with shelves
640-4-46-642-644	4552278	2262x1000x2355 with shelves
640-5-46-642-644	4552280	2805x1000x2355 with shelves
640-6-46-642-644	4552282	3356x1000x2355 with shelves

Delivery table includes guide rail sections for 460 baskets.

Delivery table, 460 baskets	Code	Dimensions mm
640-2-46	4552244	1176x1000x875±25
640-3-46	4552248	1719x1000x875±25
640-4-46	4552252	2262x1000x875±25
640-5-46	4552256	2805x1000x875±25
640-6-46	4552260	3356x1000x875±25

SORTING TABLE

Nordien-System sorting tables are available in two designs, either for placing against the wall or free standing. The wall model has an upstand at the back while the free standing model has a low edge on all four sides. The tables are normally supplied with one or two sorting shelves which are either attached to the table top or wall mounted with brackets. If only one sorting shelf is used, a basket rack can be mounted above.

The table top, as well as the sorting shelves, are provided with drainage outlet. Under the table, guide rail sections for 500x500 mm or 460x460 mm baskets are standard.

Table tops and sorting shelves in stainless steel sheet. Adjustable feet.



Sorting table includes guide rail sections for either 500x500 mm or 460x460 mm baskets are available. Mobile waste bin, plate cassettes and scraper are accessories.

Sorting table for 500 baskets

Placing against the wall	Code	Dimensions mm
600V-2-50	4552186	1176x800x875±25
600V-3-50	4552190	1719x800x875±25
600V-4-50	4552194	2262x800x875±25
600V-5-50	4552198	2805x800x875±25
600V-6-50	4552202	3356x800x875±25

Free standing

620F-2-50	4552206	1176x800x875±25
620F-3-50	4552210	1719x800x875±25
620F-4-50	4552214	2262x800x875±25
620F-5-50	4552218	2805x800x875±25
620F-6-50	4552222	3356x800x875±25

Sorting table for 460 baskets

Placing against the wall	Code	Dimensions mm
600V-2-46	4552184	1176x800x875±25
600V-3-46	4552188	1719x800x875±25
600V-4-46	4552192	2262x800x875±25
600V-5-46	4552196	2805x800x875±25
600V-6-46	4552200	3356x800x875±25

Free standing

620F-2-46	4552204	1176x800x875±25
620F-3-46	4552208	1719x800x875±25
620F-4-46	4552212	2262x800x875±25
620F-5-46	4552216	2805x800x875±25
620F-6-46	4552220	3356x800x875±25

Sorting shelf wall mounted	Code	Dimensions mm
650-2	4552284	1076x550
650-3	4552286	1619x550
650-4	4552288	2162x550
650-5	4552290	2705x550
650-6	4552292	3248x550
Brackets	Code	
654	4552118	for one shelf
653	4552116	for two shelves

Suitable for 500 and 460 baskets

BASKET RACK WALL MOUNTED



For 460 and 500 baskets	Code	Dimensions mm
501-2	4552158	1136 x 560 x 480 mm
501-3	4552160	1679 x 560 x 480 mm
501-4	4552162	2222 x 560 x 480 mm
501-5	4552164	2765 x 560 x 480 mm
501-6	4552166	3308 x 560 x 480 mm

PRE-WASH TABLES FOR HOOD TYPE MACHINES



The basin line 700-6-3 with 600 mm basin is supplied with a splash guard and a connection plate to machine; the pre-rinse shower, the unloading table and the grid shelf are accessories.

Nordien-System basin is of sturdy stainless steel throughout with guide rails for baskets. There is a large strainer at the bottom of the basin which can be lifted upwards and an outlet ball valve connection. The basin depth is 300 mm. Adjustable feet. Connection plates available in lengths 300 mm and for angled installation 500 mm. The basins are supplied with splash guards.

Basin	Code	Outer dimensions mm	Installation length
300 mm connection plate:			
700-11-3	4552316	1100x590x880±25	1400 mm
700-6-3	4552320	600x590x880±25	900 mm
700D-6-3, 2 basins	4552332	1200x590x880±25	1500 mm

500 mm connection plate for angled installation:			
700-11-5	4552319	1100x590x880±25	1600 mm
700-6-5	4552317	600x590x880±25	1100 mm
700D-6-5, 2 basins	4552321	1200x590x880±25	1700 mm

Accessories:	Code	Dimensions mm	For basins
Grid shelf	4552324	600x590	700-6-3, 700-6-5
Grid shelf	4552326	1100x590	700-11-3, 700-11-5
Grid shelf	4552328	1200x590	700D-6-3, 700D-6-5
Unloading table	4552325	500x590	

DRYING LINE

Nordien-System drying line for hood type dishwashing machines. The construction is of sturdy stainless steel throughout. Drip tray with outlet drainage. Guide rail section for storage of empty 500 x 500 mm baskets. Adjustable feet.

Drying line	Code	Dimensions mm	Guide rail sections
750-0	4552345	700x580x875±25	1
750-1	4552346	1100x580x875±25	1
750-2	4552348	1600x580x875±25	2
750-3	4552350	2100x580x875±25	3



Double basin line 700D-6 with two 600 mm basins.



Drying line 750-1.

METOS PRE-WASH SHOWERS



6546 pre-wash shower

Europe line of pre-rinse showers 4013-, 3050, 4023 and 3034 are traditional pre-wash showers with a handled jet pistol. Pre-wash showers are supported at the top with a wall fitting. The shower is started by pushing down the handle. A spring returns the handle to its initial position. Metos 4013 (wall mounted) and Metos 3050 (table mounted) are pre-rinse showers with a down spout and a mixer with two grips. WM 4023 (wall mounted) and TM 3034 (table mounted) are pre-rinse showers with a downspout and a mixer with a long single grip lever.

Europe line	Code	Dimensions mm
Metos WM 4013 (wall, two grips)	4218439	h 1050
Metos TM 3050 (table, two grips)	4218441	h 1500
Metos WM 4023 (wall, single grip)	4218443	h 1050
Metos TM 3034 (table, single grip)	4218445	h 1300

Top line pre-wash showers 6546 (table mounted) and 6548 (wall mounted) are Top line pre-wash showers with a thermostatic mixer and a downspout. Top line showers start automatically when the jet pistol is pulled down. The showers are supported at the top by a wall fitting. The showers come with an 2,5 m extension hose, which can be attached to the shower using a bayonet catch (included). By using the extension the showers can be used for cleaning the washing area.

Top Line	Code	Dimensions mm
Metos 6546 table	4218431	h 1250
Metos 6548 wall	4218495	h 950



WM 4013



6548 pre-wash shower

WASHING PISTOL

Washing pistol with hose reel is wall mounted and can be used for pre-rinsing, cleaning the dishwashing machine and other surroundings. The spray cone can be adjusted from the ergonomic grip. The length of the hose is 8 metres. Thermostatic mixer is an option.

Washing pistol	Code
Washing pistol	4197996
Washing pistol with hose reel	4551900
Thermostatic mixer	4552034
Mixer	4552036



The washing pistol with hose reel for handy cleaning.



TM 3034



POWERED TURN TRACK



Powered turn track 445, 180°.

Nordien-System powered tum track for transporting baskets by friction driven conical rollers is connected to exit end of the rack conveyor machine. Operates with all dishwashing baskets and rack conveyor machines. The unique construction guarantees a smooth movement of baskets. All stainless steel construction. Outlet connection.

The range includes both 90 degree and 180 degree curves.

Powered tum track	Code	Dimensions mm
445 180°	4552102	780x1400x875±25
446 90°	4552104	780x780x875±25

Accessories	Code	Dimensions mm
Roller connection 454	4552106	length 300 mm
Connection plate steel 456	4552108	length 300 mm



Powered turn track 446, 90°.



Roller connection 454.



Connection plate 456.



Drain in the bottom of the basin.

ROLLER TABLE



The roller sections are easy to lift for washing.



Static roller table 465-3 with two guide rail sections.



Unloading table 430.

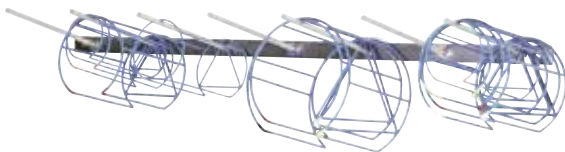

Plate cassette holder wall mounted holder	Code	Dimensions mm
502-2	4552168	1120
502-3	4552170	1660
502-4	4552172	2200

Plate cassette holder for drying line	Code	Dimensions mm
502T-2	4552174	1120
502T-3	4552176	1660
502T-4	4552178	2200
502T-5	4552180	2535
502T-6	4552182	3060

Nordien-System roller table is attached to the exit of the machine or powered turn track. The construction is of stainless steel. Resistant full length plastic rollers with ball bearings. The roller sections are easy to lift for washing. Outlet drainage either into turn track or from the bottom of the unit. Shelf and rails for storing empty 500 x 500 baskets. Adjustable height.

Pivoted table has four 125 mm ball bearing wheels, two with brakes. If the roller table is connected to a 180 degree curve a pivoted model is advisable.

Pivoted roller table for 180 degree curve	Dimensions mm	Guide rail sections	
460-2	4552138	1060x630x875±25	1
460-3	4552140	1585x630x875±25	2
460-4	4552142	2110x630x875±25	3
460-5	4552144	2635x630x875±25	4
460-6	4552146	3160x630x875±25	5

Static roller table for 90 degree curve	Dimensions mm	Guide rail sections	
465-2	4552148	1060x630x875±25	1
465-3	4552150	1585x630x875±25	2
465-4	4552152	2110x630x875±25	3
465-5	4552154	2635x630x875±25	4
465-6	4552156	3160x630x875±25	5

Static roller table for connection to rack conveyor machine	Dimensions mm	Guide rail sections	
465-2D-WD	4552145	1060x630x875±25	1
465-3D-WD	4552149	1585x630x875±25	2
465-4D-WD	4552151	2110x630x875±25	3
465-5D-WD	4552161	2635x630x875±25	4
465-6D-WD	4552163	3160x630x875±25	5

Accessories	Code	Dimensions mm
Unloading table 430	4552100	width 500 mm depth 300 mm



 **NORDIEN-SYSTEM**

Metos Manufacturing

Ahjonkaarre

FI-04220 Kerava, Finland

Tel +358 204 3913

international.sales@metos.com

www.metos.com/manufacturing