

# unitray



**rational**<sup>o</sup>  
production

MEAL  
DISTRIBUTION  
SPECIALISTS

Unitray is our **thermo-refrigerated** convection trolley with on-board technology for hot&cold meal distribution on trays.



## Fields

Unitray is intended for collective contexts, in particular in **the area of healthcare, companies, schools and prisons.**



hospitals  
and nursing  
homes



companies



schools



prisons

## Category features

01. **HOT&COLD TRAY**  
Trolley fitted with a dividing wall to ensure proper insulation between the hot and cold parts of the tray.
02. **ACTIVE CONVECTION TECHNOLOGY**  
Convection technology to preserve the food's organoleptic qualities during both the temperature holding /boost cycles (C&S) and during the regeneration cycles (C&C or C&F).
03. **ON-BOARD TECHNOLOGY**  
Plug-in trolley that is flexible and easy to implement in any context. Equipped with an on-board computer for better workflow management and more efficient temperature monitoring in compliance with HACCP regulations.

# Sizes and trays

## Small size



**capacity**

20 trays	pitch 91.15 mm
24 trays	pitch 79 mm

## Large size



**capacity**

26 trays	pitch 91.15 mm
30 trays	pitch 79 mm

## Sectioned tray

To ensure better hygiene during the entire workflow.

50% HOT — 50% COLD

**sizes available**

- GN 1/1 530x325 mm
- EXT 565x332.5 mm



**colours**

- cappuccino
- grey

## Flat tray

Without sections, for better ergonomics for the patient during the meal and with the possibility of increasing the hot or cold surface area as needed.

50% HOT — 50% COLD (+/- 3%)

**sizes available**

- GN 1/1 530x325 mm

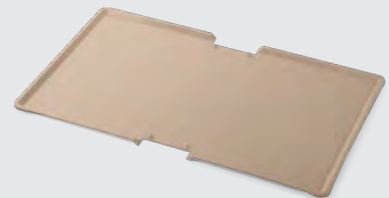

**colours**

- cappuccino
- grey

63% HOT — 37% COLD

**sizes available**

- GN 1/1 530x325 mm



**colours**

- cappuccino
- grey

# Cook and serve

## Workflow

**TIPS!** The recommended cycle length is 20 minutes:

- +100°C for the hot compartment;
- +3°C for the cold compartment.

Once the cycle is completed, when connected to the power supply **Unitray** can actively hold the set temperatures until it is sent to its final destination. When disconnected, **Unitray** is able to passively hold the correct temperatures for up to 60 minutes from the time it was disconnected from the power supply (time limit varies according to menu / local regulations / cycles used / environmental conditions).

### What it is

The C&S work system involves the preparation of hot meals just before delivery, for each service. **Unitray** ensures the correct temperature holding of hot and cold meals from the moment they are prepared to when they are delivered to the guest.

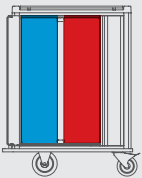

**Unitray C&S**  
ventilated cold compartment  
from 3 kW to 6.5 kW/  
ventilated hot compartment

### 01. PREPARATION

For each breakfast, lunch or dinner service, meals are prepared in the kitchen or in a room used for this function.

### 02. PLATING

Still in the kitchen or area dedicated to plating, the meals, held at a correct temperature according to HACCP standards, are divided into portions and placed on personalized trays.

### 03. LOADING

The trays are loaded inside **Unitray** and then transported to the area where the cycle will be carried out.

### 04. TEMPERATURE BOOST

Once connected to the power supply, selecting one of various pre programmed cycles, **Unitray** is able to hold or even improve (if necessary) the hot and cold temperatures of the contained meals, due to the active convection system in both compartments.

### 07. CLEANING

Once it is returned to the kitchen with the trays, **Unitray** is washed and sanitised, ready to be used for the next service.

### 06. DISTRIBUTION

**Unitray** passively holds food temperatures until it reaches destination, where the customised tray is then delivered directly to the guest. The tray is then collected at the end of the service.



# Cook and chill / Cook and freeze

## Workflow

**TIPS!** The recommended cycle length for Cook&Chill is 45 minutes:

- +115°C for 25 minutes + 90°C for 20 minutes;
- +3°C for the hot compartment.

Once the cycle is completed, when connected to the power supply **Unitray** can actively hold the set temperatures until it is sent to its final destination. When disconnected, **Unitray** is able to passively hold the correct temperatures for up to 60 minutes from the time it was disconnected from the power supply (time limit varies according to menu / local regulations / cycles used / environmental conditions).

### What it is

**Unitray** when configured for C&C/C&F, features a multifunctional hot/cold compartment and a cold compartment, both ventilated. Recommended power from 6.5 kW to 9.8 kW.

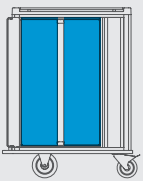

cold compartment  
/ cold compartment

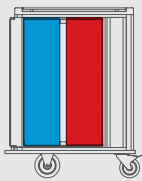

cold compartment  
/ hot compartment



#### 07. CLEANING

Once it is returned to the kitchen with the trays, **Unitray** is then washed and sanitised, ready to be used for the next service.



#### 06. DISTRIBUTION

Once it reaches destination, the personalized tray is then delivered directly to the guest, without any additional handling. The tray is then collected at the end of the service.



#### 05. REGENERATION

At a preset time, the regeneration cycle will be activated automatically. The multifunctional cold compartment automatically switches from cold to hot, to regenerate meals at the correct HACCP temperature, while the cold compartment remains active.



#### 04. COLD HOLDING

Once connected to the power supply, **Unitray** will actively hold the cold chain in the two convection compartments.



#### 02. PLATING

In a temperature-controlled area dedicated to plating, the meals are divided into portions while still cold and placed on personalized trays.



#### 03. LOADING

The still cold trays are then loaded inside the **Unitray**, to be transported to the regeneration area. In this situation, **Unitray** passively holds the food's temperature.



#### EXTERNAL TRANSPORT

**Unitray's** perfect **insulation** also makes it the ideal solution for external transport (i.e. for centralised kitchens or satellite facilities) by lorry or alternative means.

# Features

## Ergonomic handle

Placed at an ergonomic height and protected from lateral impacts.



## Dividing wall with double seal

Double seal barrier and elimination of thermal points for HACCP-proof insulation for both the hot and cold parts.



## Internal chamber with rounded corners

Easy to clean thanks to its flush surfaces and wide corners, both internally as well as externally.

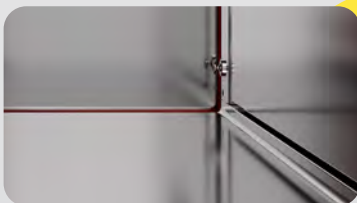

## Perimetral bumpers

Designed to protect all parts of the trolley, especially the doors, even in an open position. This applies to both single door (2-door configuration) and folding door (4-door configuration).

## Flat lid

A large surface is provided on the top of the trolley with standard aluminium barriers. The maximum load is 20 kg.

## Cable protection compartment

A secure place from which to retrieve the cable while moving the trolley, when not in use. This eliminates damage to the cable during transportation.



## Heavy-duty castors

Available in a 4- or 6-castors model and configurable according to material type and braking system.

## Condensation drip tray

The recessed design makes emptying easier without compromising on hygiene.



# Design

## Aesthetics

Premium, linear design available in **Yellow** or **Blue**.



## Functionality

Each part of the trolley remains inside the original volume of the equipment, including optionals:

- greater ergonomics and operator safety
- reduced risk of damage



## Hygiene

The flush surfaces and wide corners limit the accumulation of grime and make cleaning easier, both internally and externally. **Unitray** is IPX5 certified (except Zeroeffort versions - IPX4).

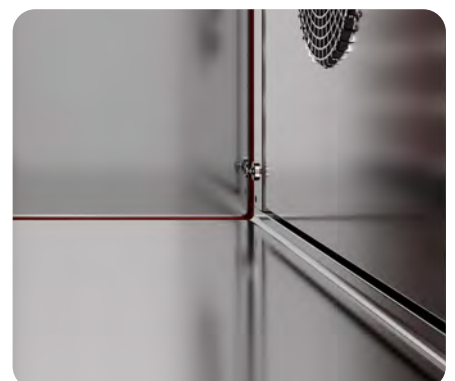
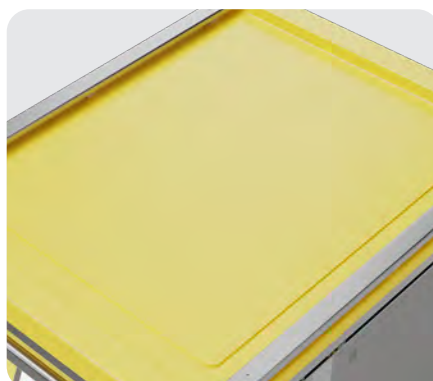

# Standard technologies

## equalconvect

**Equalconvect** is the finest convection heating technology on the market due to an array of solutions that combine our know-how in aerodynamic flows and ad hoc technical solutions for heat management.

- **Greater air flow rate** compared to market standards.
- Horizontal **airflow** and **optimised in** uniformity.
- **Axial fans** for smarter air distribution.

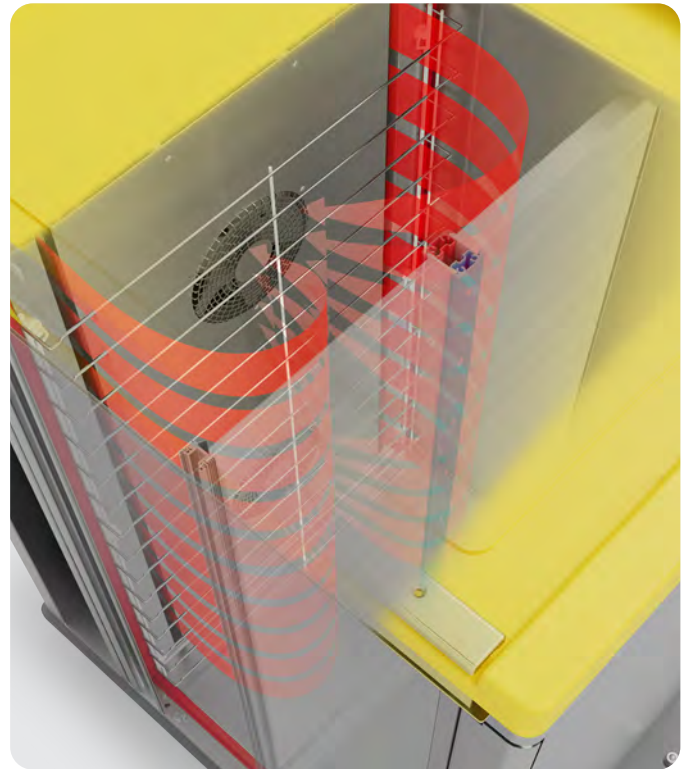

### Greater versatility at your disposal

Equalconvect's extra airflow can be used both for optimising workflows with sprint cycles (boost cycle from 12 minutes and regeneration from 35 minutes) and for searching for optimum quality with low-temperature regenerations (from 90°C).



#### Balanced

A compromise between time-quality

#### Quality

Low-temperature regeneration

#### Speed

Sprint cycles



### Temperature uniformity

Smart distribution of a greater quantity of air, compared to the market standard, conveyed in horizontal flows so as to reach each tray uniformly.



### Quality and makes food appetizing

Option of low temperature regeneration to maintain the organoleptic properties of meals.

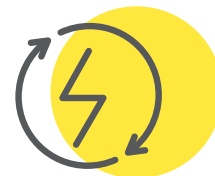

### Energy saving

25% more efficient than the previous range.





## aluframe

Borrowed from the world of aeronautics, Aluframe technology is the basis for developing a compact, lightweight, seamless perimetral frame with a structure formed by extruded anodised aluminium profiles interlocked by screwed corner joints.

- Screwed profiles for **easy dismantling**.
- Perimetral frame for greater **compactness**.
- Aluminium: **3 times lighter than steel** without compromising on **sturdiness**.
- **Recycled** and **recyclable** aluminium.
- The aluminium profile was designed to facilitate **the total elimination of thermal bridges** with the internal stainless steel chamber.

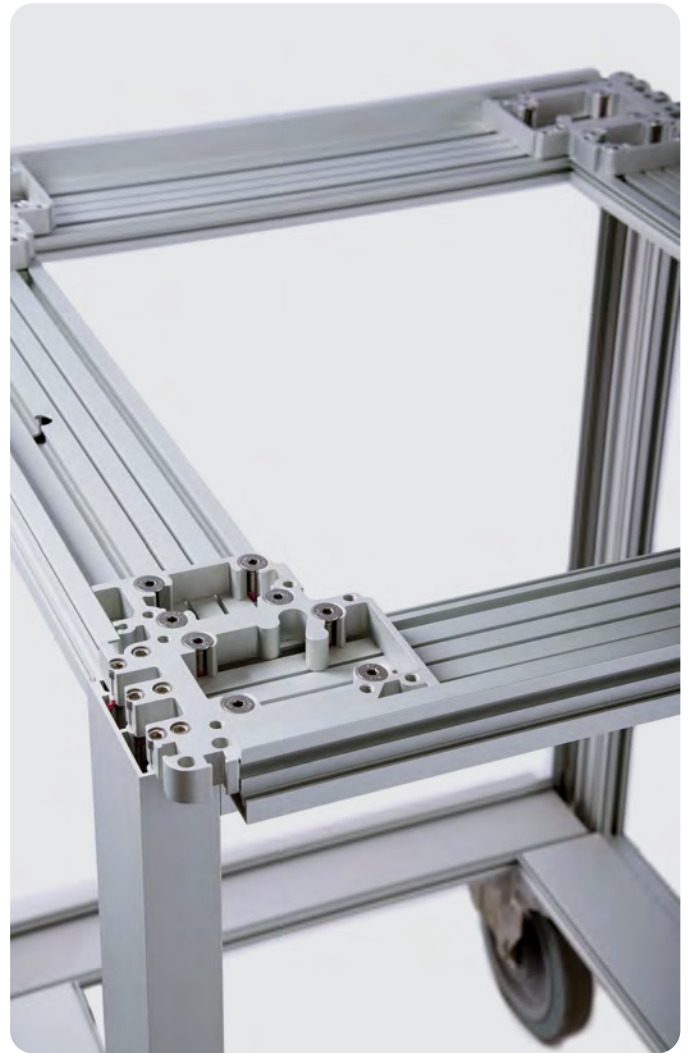

### Ergonomics

Aluframe makes **Unitray** the lightest trolley on the market. It also provides extraordinary compactness, particularly in height, which benefits handling.



### Sustainable

The frame is made with recycled aluminium and is totally recyclable at the end of the product life.

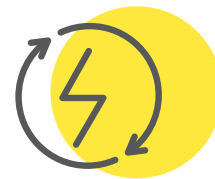

### Energy saving

Increased product life due to the possibility of replacing individual frame profiles and improved thermal insulation thereby limiting energy consumption.



## intelliflow

**Intelliflow** is the new control system designed to be easily accessible and to completely eliminate operating errors. Based on the Linux operating system, **Intelliflow** is our new solution for intuitive and simple control of the equipment, using a handy 7" touchscreen.



Simple and intuitive interface.



Extensive control and diagnostic system.

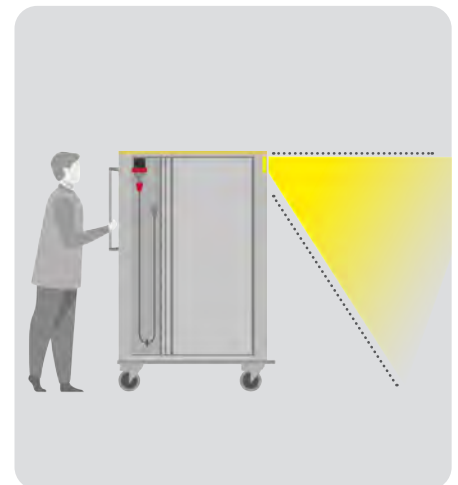

Integrated camera for safe handling (optional).



### User friendly

Improved user-experience thanks to a software and hardware architecture that facilitates learning and minimises operating errors.



### Safety

Extensive control/diagnostic system to monitor the proper functioning of the trolley according to HACCP standards.

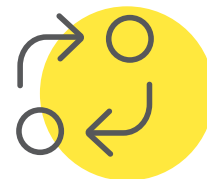

### Connectivity

Possibility of connecting to peripheral devices or proprietary software, such as our **Communicator**, or even third parties, via the Linux operating system.

# Optional technologies



**Communicator** is the software for monitoring distribution processes according to HACCP principles and for managing the equipment fleet. **Communicator** is available in two versions according to tracking needs: **Basic** and **Premium**.

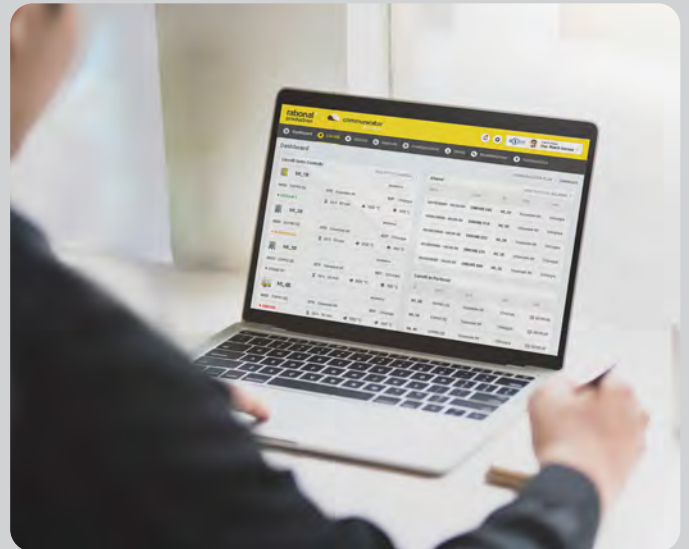

**Communicator basic**  
Entry-level, easy to install and use, economic, created to meet the needs of small facilities.

USB key
✓
✓
✓
✓
✓
✓
✓
✗
✗
✗

**Functionality**

Communication Technology
Temperature Log
Alarm Log
Multi-system management
Management personnel authorisations
Trolley programming back-up
Personalization of alarms and operating instructions
Real-time monitoring
Remote control and programming
Installation on a local server

**Communicator premium**  
Complete and real-time connectivity. It enables timely remote intervention, with the possibility of keeping data on the cloud or on a local server.

Wifi
✓
✓
✓
✓
✓
✓
✓
✓
✓
✓



**HACCP Safety**  
The possibility of monitoring and registering working temperatures, detecting any anomalies in advance, thus ensuring a high level of food safety and timely intervention by the operator.

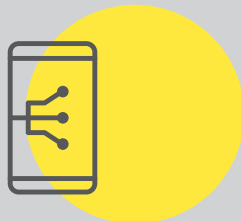

**Accessibility**  
With the cloud-based system, operators are able to access communicator from any device in their possession.



**Economic savings**  
Reduced costs and reduced on-site intervention time by tracking the equipment performance data and sharing it with accredited service centres.

# zeroeffort

**Zeroeffort** is the range of assisted handling solutions with integrated electric motors. It is available in two versions, **hybrid** and **climb**, supporting operator ergonomics and safety.

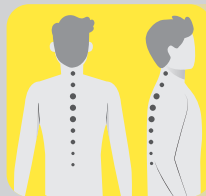

## zero additional costs

The ZEROEFFORT optional feature allows the trolley to be handled by a single operator providing important savings on personnel costs.

## zero MSD

Musculoskeletal disorders (MSDs) are one of the most common disorders related to handling. With zeroeffort technology, work-related MSD risks affecting the back, neck, shoulders, upper and lower limbs are minimised.

### Zeroeffort Hybrid

is the patented solution that facilitates handling on level routes, provides electrical support to the operator's normal push, reducing effort to a minimum.

Magnetically driven electric motor

100 W (x2)

Lithium Iron Phosphate (LiFePO4)

1 hour (during regeneration cycle)

1 hour (continuous use)

2 hours (use during service)

IPX4

<58 Db



Patented by Rational Production

### Functionality

Technology

Motor power

Batteries

Complete recharging time

Battery autonomy

Ingress protection code

Noise level

Automatic uphill/downhill brake

Manual handling

Emergency button

Patent

### Zeroeffort Climb

is the 100% motorised version, with a direct connection between motor and castors, making it the highest performing and most suitable solution for safely negotiating ramps.

Electric motor with mechanical drive

560W

Lead (Pb)

10 hours

2 hours (continuous use)

4 hours (use during service)

IPX4

<58 Db





## Zeroeffort **hybrid**



### Intuitive

The control is integrated in the push handle for easy handling from the very first use.

### Optimised

The 6-kg thrust provided by the electric motors allows the operator to move the trolley effortlessly.



### Patented

The patented magnetic clutch allows use even in the event of a breakdown or with dead batteries.



## Zeroeffort **climb**



### Precise

The butterfly throttle allows the trolley to be accurately controlled, even in tight spaces.



### Flexible

Four speeds are available, two speeds for each direction of movement.



### Safe

The power of the motor, combined with the automatic uphill and downhill braking system, is certified to deal with 15% gradient ramps in total safety.



# Options

## Logistics solutions

### Tow bar

A stainless-steel pivoting hitch allows up to four trolleys to be towed by one tow tractor simultaneously.

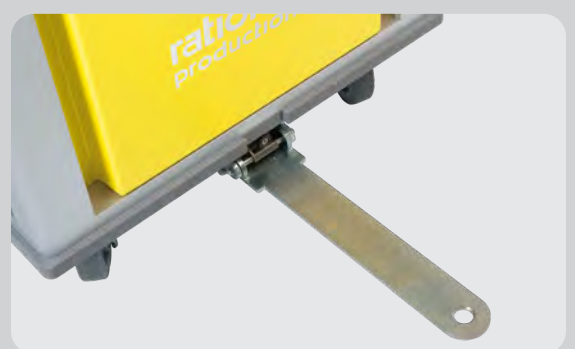
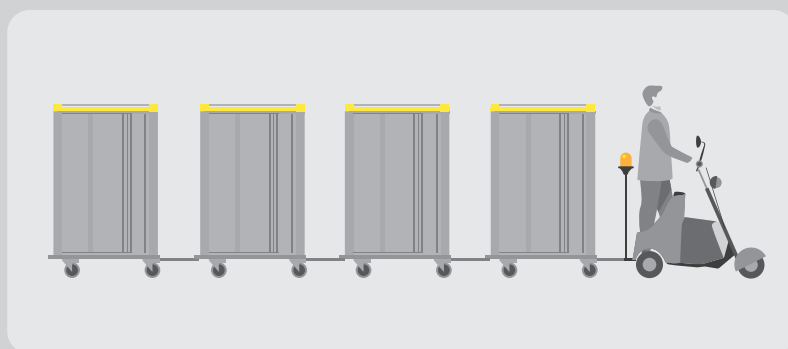

### AGV/AMR

When handling using AGVs or AMRs, the trolley base can be modified according to the specifications required by the robot.

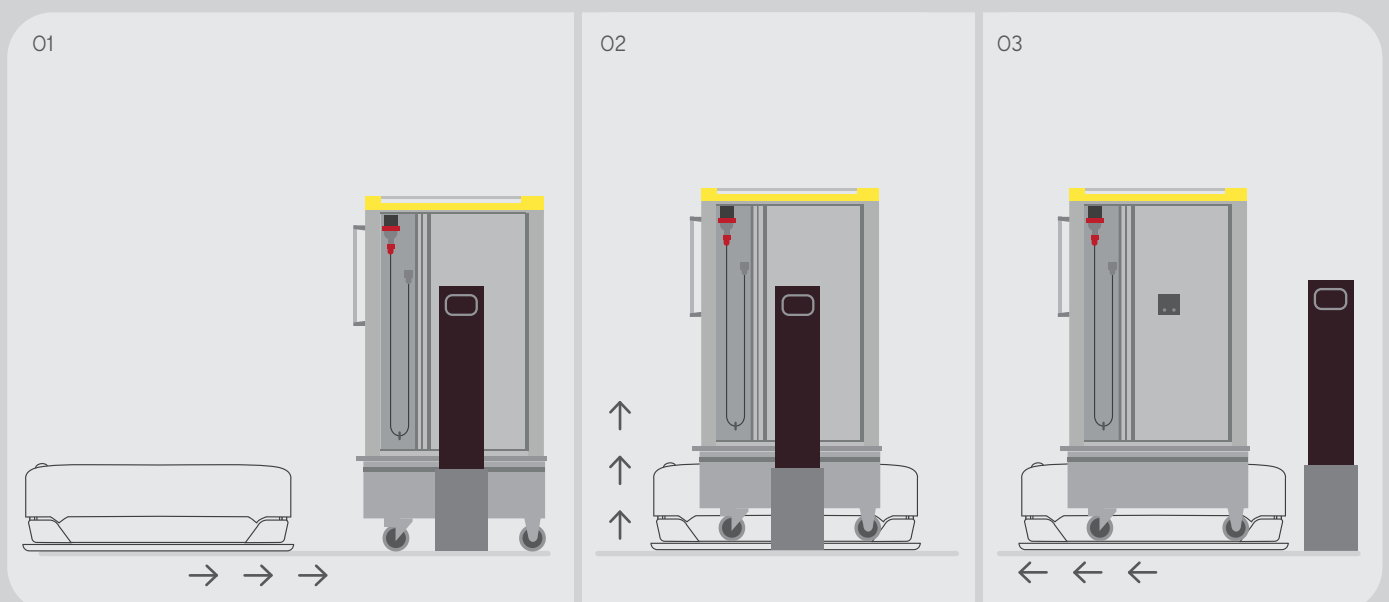

## Removable rack

The configuration with a removable rack allows you to use **Unitray** for the thermal cycle and to move meals on a lighter trolley (neutral shuttle) from the kitchen to the ward.

The ergonomic handle allows the operator to remove/insert the rack easily by sliding it on special runners.



## Uniserv neutral shuttle range



### Uniserv Jolly

open shuttle



### Standard Uniserv

closed shuttle



### Uniserv Plus

closed and insulated shuttle

# Options

## Castors

Quantity

4 (standard) 2 swivel Ø160 mm | 2 fixed Ø200 mm

6 (optional): 4 swivel Ø160 mm | 2 fixed Ø200 mm

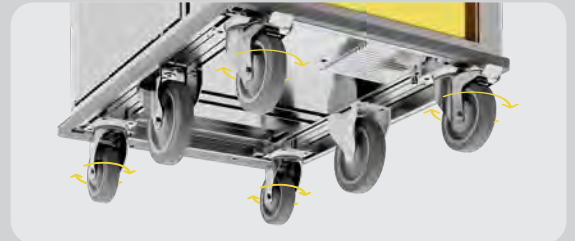
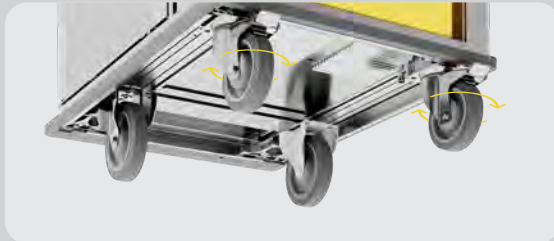

Brake type

Single brake (standard)

Centralised brake (optional)



Material

Galvanised iron (standard)

Stainless steel (optional)

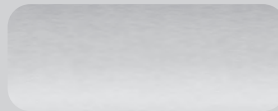

## Doors

2 doors (standard)

01



02

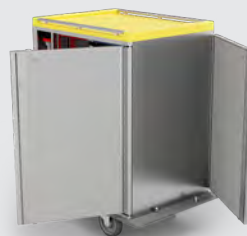

03



4 doors (optional)

The folding door design halves the space required to open the doors.

01



02

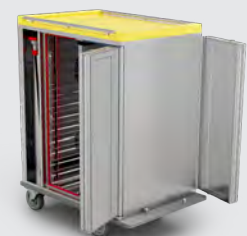

03







#### Folding shelf

Additional work surface that can be used both when distributing meals and collecting trays.



#### Adhesive perimetral guard

Protective pvc band, mounted at handle height to prevent aesthetic damage to the trolley.



#### Bag holder

An accessory to the folding shelf, which can be mounted on either the right or left side, allows the housing of 1/3 GN containers or a bag that can be used when trays are collected.



#### Upper corner bumpers

In addition to the base-mounted perimeter bumper, they provide the trolley body with additional protection



#### Tray separation grid

Separator between the two rows of trays, prevents food from shifting or falling during transport.



#### Reduced bumper

An alternative to the perimetral bumper, it reduces the overall size of the trolley, making it even more compact.



#### Vertical handles

In addition to the standard push bar, it improves ergonomics when handling the trolley.



#### Multipower

Optimisation system for energy peaks, allows the trolley's power to be cut when the temperature set during the cycle is reached.



#### Door lock

Locking of doors to prevent unauthorised opening.

# Accessories

## Crockery and lids

Standard set of high-quality crockery and matching heat-resistant polypropylene lids, designed to facilitate collective catering services, ensuring optimum performance during the heating cycle and during delivery.



### ROUND DISH

Crockery size  
Ø215 x 21h mm

Lid size  
Ø216 x 53.5h mm



### RECTANGULAR DISH

Crockery size  
177 x 111 x 35h mm

Lid size  
177 x 111 x 28h mm



### SQUARE DISH

Crockery size  
120 x 120 x 42h mm

Lid size  
115 x 115 x 37h mm



### ROUND BOWL

Crockery size  
Ø135 x 69 mm

Lid size  
Ø122 x 18h mm

### LID COLOURS



Yellow



Orange



### ID tag

Available in PVC or stainless steel, it can be used to identify the destination of the trolley and/or attach documents.



### External food core probe

Used to measure the core temperature of foods, before or after the thermal cycle.

# Technical data

Unitray	S (Small)	L (Large)
Size	766 x 1049 x 1360h mm	766 x 1049 x 1597h mm
Weight	176 kg	195 kg
Tray capacity	20 - 24	26 - 30
Electrical power supply	380/400V or 220/230V   single- or 3-phase	
Frequency	50 / 60 Hz	
Power	from 3.0 to 9.1 kW	
Hot compartment maximum temperature	+130 °C	
Cold compartment minimum temperature	-3 °C	
Ingress protection code (IP)	IPX5 (IPX4 for the versions with Zeroeffort)	
Certifications	CE, IEC CB Scheme	
Interior	AISI 304 stainless steel chamber and tray support. Dividing wall: Made of aluminium and synthetic material, heat-resistant, fully washable.	
Exterior	Heavy-gauge anodic oxidation-treated aluminium shell that is easily cleaned. Thermoformed ABS upper lid and front panel. Impact-resistant HPL panels. Perimeter bumpers made of high-density polyethylene. Horizontal ergonomic handle.	
Control panel	Touch-screen display, 7 inches, with frame made of impact-resistant thermoformed ABS. 100 programmable thermal cycles.	
Castors (standard)	Heavy-duty castors with double precision ball bearings (2 swivel Ø160 mm with brake, 2 fixed Ø200 mm).	

# **BGL Rieber**

META Cooking

If you have a need for distributing meals  
...call the experts

**Call:** 01225 704470

**Email:** sales@bglrieber.co.uk

**BGL Rieber Ltd.**

Unit 1 Lincoln Ind Estate  
Avro Business Centre  
Avro Way, Bowerhill  
Melksham, SN12 6TP

[www.bglrieber.co.uk](http://www.bglrieber.co.uk)

Made in Italy | Great in Britain | Greener by Design

**rational**<sup>o</sup>  
production

MEAL  
DISTRIBUTION  
SPECIALISTS

Rational Production srl  
Via L. Galvani, 7/H  
24061 Albano S. Alessandro (BG)  
Italy

T. +39 035.452.1203  
F. +39 035.452.1983  
info@rationalproduction.com  
www.rationalproduction.com